

## Wahl-Eversharp Fountain Pen Desk Sets—Continued

The coloring in Pedrara Onyx, from which WAHL-EVERSHARP bases are made, ranges from virgin white, through the most exquisite tints of green, rose, yellow, brown and some blue—appearing in delicate veins or broad bands, or in cloudlike masses of rich color. It is this infinite variety of wonderful and beautiful marks and tints that lend to our Pedrara Onyx bases their chief charm and place them in a class by themselves as a decorative stone.

Italian Portoro Marble, commonly called "Black and Gold," comes to us from Italy. Throughout Europe there are a number of quarries producing Black and Gold marble, but we insist that ours comes from those quarries where is produced a marble that has been selected by our European representatives as being best suited to our use. To insure only perfect stone, each block is carefully inspected before shipping to this country, where it is reinspected before being cut or polished. Without

this careful inspection we could not offer our dealers the very best grade of Black and Gold Marble obtainable.

Argentine Onyx is produced and brought to us from the only known quarry located in the Republic of Argentina in South America. In composition this Onyx is very similar to Pedrara Onyx—the chief difference being its color, which is almost entirely green, with occasional streaks of subdued red or brown. Only this imported Onyx contains these beautiful colors, in addition to being of perfect composition. Our foreign representatives have selected this stone for its beauty and quality, that we might have the benefit of the years of experience of European and Latin American fabricators.

The Black Carrara Glass used in the manufacture of our desk set bases is produced in our own country by the largest plate glass manufacturers. Imported glass will not respond to the various polishing operations necessary to produce our high quality bases.



**WAHL - EVERSHARP**

**EXECUTIVE Fountain Pen Desk Set** with beautiful lamp attachment. This set will add beauty and dignity to the executive's desk. The bronze shade may be adjusted to throw light well over the desk. Base of Pedraza Onyx with two pencil grooves and fancy beveled edge. Size approximately 8" x 13". Whenever a touch of beauty is desired in the modern executive office, this set will add that touch and at the same time supply a daily need.

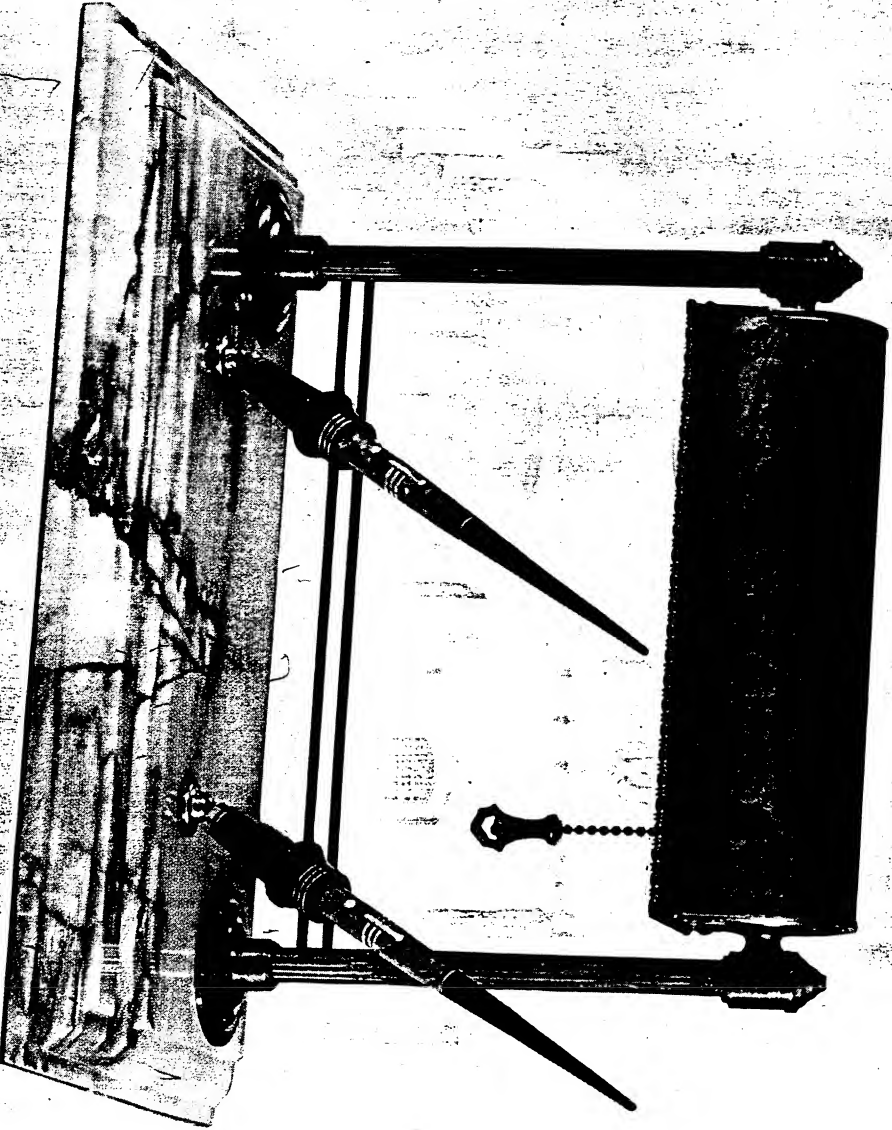

No. 8155NX-W-65—Complete with two No. 7612DP Jade green *Personal Point* Desk Pens with No. 6 Gold Seal Interchangeable nibs, a choice of fourteen points

*List Price: \$85.00*  
(on Pacific Coast \$95.00)

No. 8155AX-W-63—Argentine Onyx base, mounted with two No. 7605DP Bronze-Green *Personal Point* Desk Pens

*List Price: \$85.00*  
(on Pacific Coast \$95.00)

**MONOGRAM PLATES**

Applicable to any Desk Set

(For Illustrations see page 65)

MP-5 Shield, Satin Gold Plate.....\$1.50  
MP-6 Arrowhead, Satin Gold Plate.....\$1.50  
MP-7 Oval, Satin Gold Plate.....\$1.50

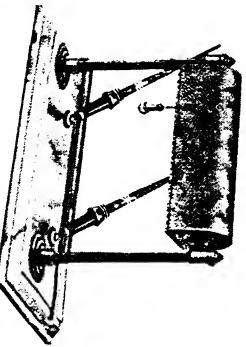

**WAHL - EVERSHARP**

A BEAUTIFUL *Desk Lamp Set* for the executive desk where only one pen is needed, or for those who prefer the oval base. The lamp stand is Antique Gold Finished, mounted with a green shade trimmed with a gold band. The base is oval and measures approximately 10" in diameter by 1" thick. Base is fitted with one No. 7610DP Jet Black *Personal-Point* desk pen, with No. 6 Gold Seal Interchangeable nib. All No. 6 desk pen nibs are interchangeable with No. 6 pocket pens.

No. 10RML - Desk Lamp Set  
 Code: TWERY *List Price:* \$50.00  
 (On Pacific Coast, \$55.00)

**MONOGRAM PLATES**  
 Applicable to any Desk Set  
 (For Illustrations see page 65)

*Prices include mounting on base*  
 MP-5 Shield, Satin Gold Plate.....\$1.50  
 MP-6 Arrowhead, Satin Gold Plate.....\$1.50  
 MP-7 Oval, Satin Gold Plate.....\$1.50

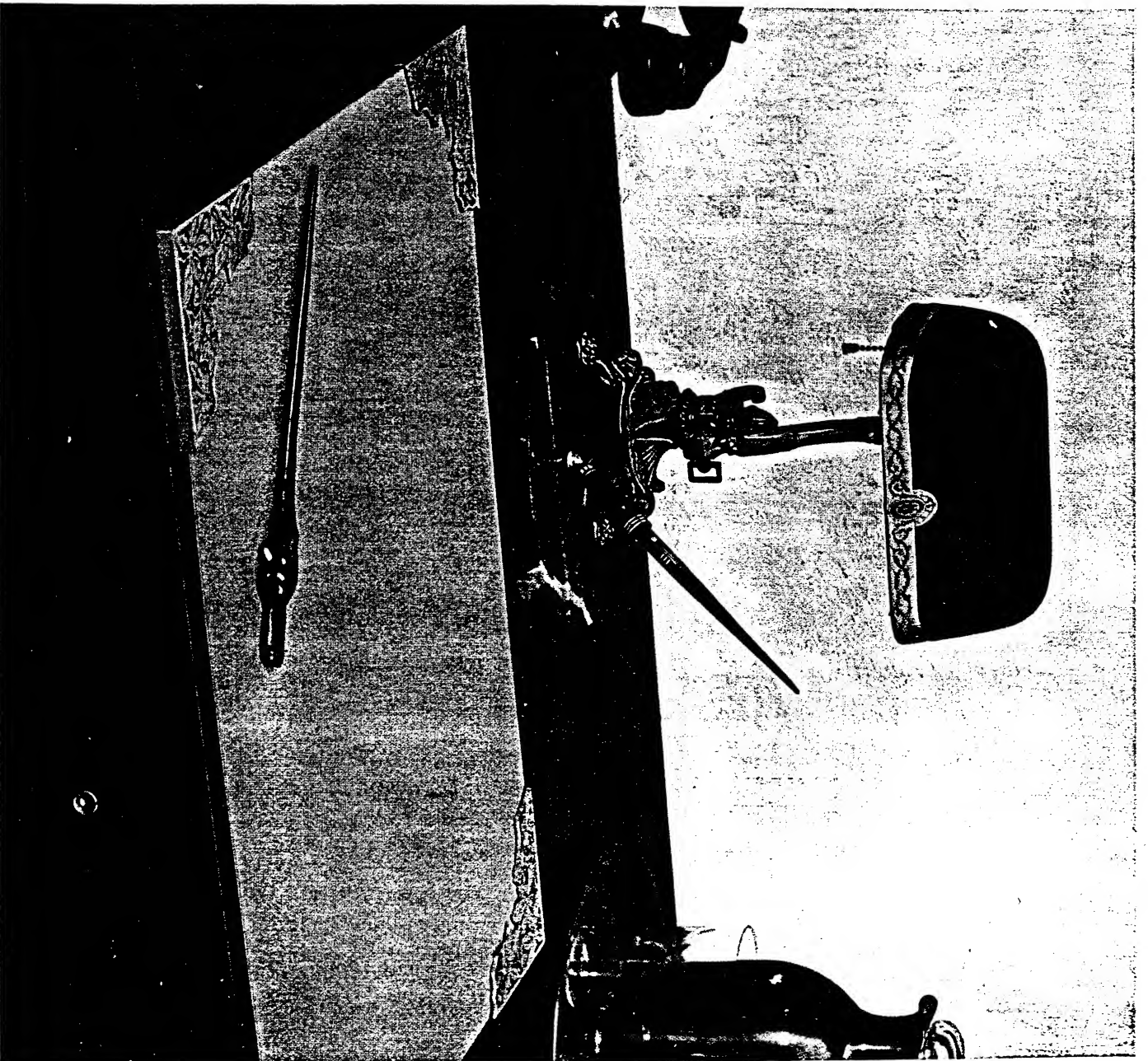
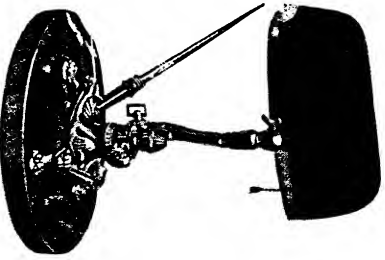

**WAHL - EVERSHARP**

For the desk requiring both beauty and utility, this *Fineville Lamp Set* will be the choice of discriminating men. The handsome bronze lamp is mounted with a green shade, affording a soft white light.

The base accommodates two Pelham Onyx fountain pen desk sets, each 2 7/8" square. Set is mounted with two No. 7607DP Rosewood *Permanet-Point Desk Pens*, fitted with No. 6 Gold Seal Interchangeable nibs.

No. 8734E—*Illustrated*. Dormer Eversharp Lamp Set

Code: SMOKE *List Price: \$55.00*  
(On Pacific Coast, \$40.00)

No. 8734EF—Same as above, except fitted with one desk set only

Code: SMOKE *List Price: \$25.00*  
(On Pacific Coast, \$30.00)

No. 0765—Sister Eversharp. One No. 7407DP desk pen mounted on bronze base

Code: VVARI *List Price: \$24.00*  
(On Pacific Coast, \$30.00)

No. 0764—Dormer Eversharp. Two No. 7407DP desk pens mounted on bronze base

Code: AVARI *List Price: \$35.50*  
(On Pacific Coast, \$40.00)

**MONOGRAM PLATES**

Applicable to any Desk Set  
(For Illustrations see page 65)

*Prices include mounting on base*

- MP-5 Shield, Satin Gold Plate.....\$1.50
- MP-6 Arrowhead, Satin Gold Plate.....\$1.50
- MP-7 Oval, Satin Gold Plate.....\$1.50

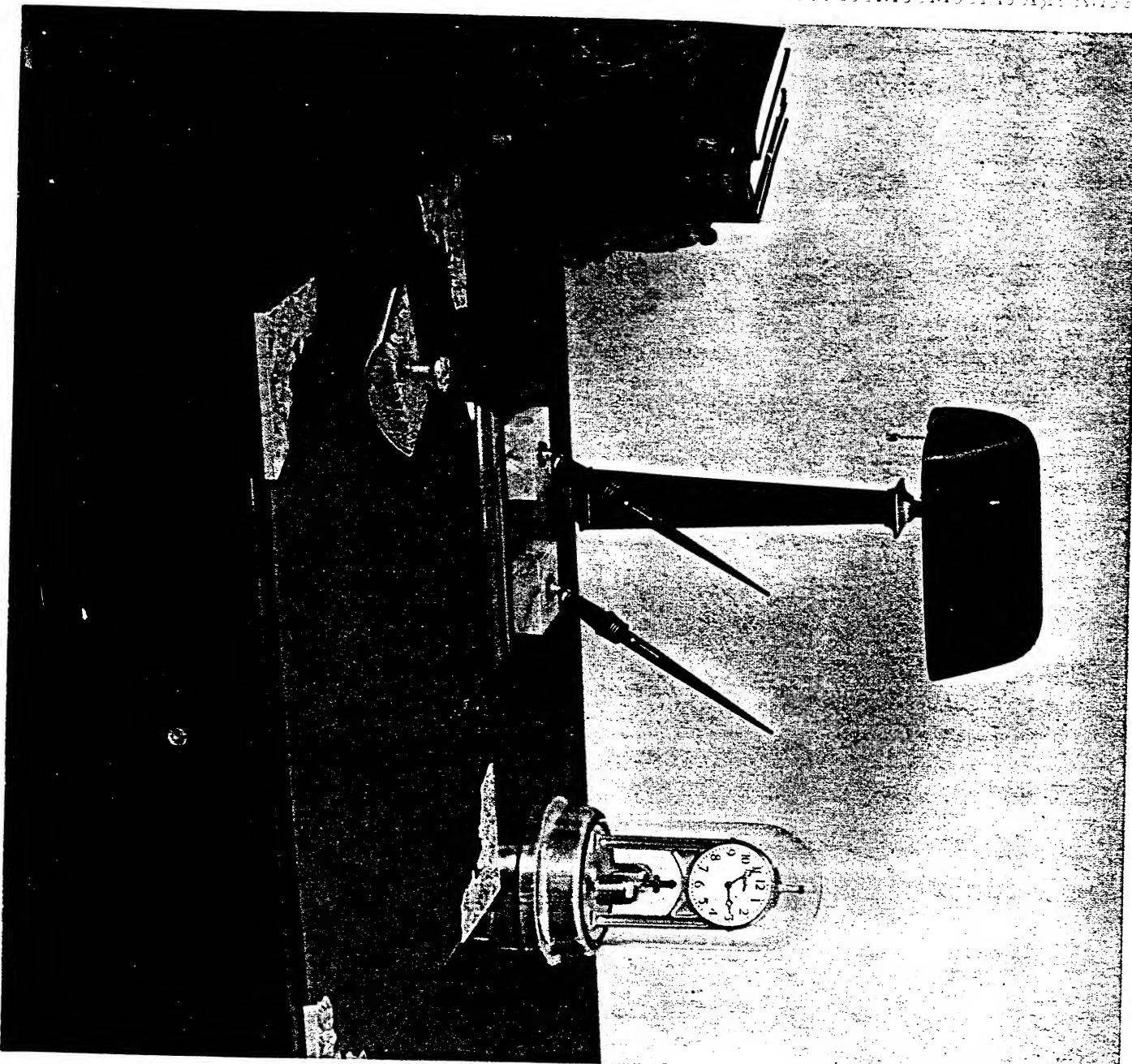

WAHL - EVERSHARP

From quarries in far-away Argentina we have brought this rare green cast Onyx for the base of the set shown here. On the desk it radiates both beauty and efficiency.

The base measures approximately 8" x 13". The edges are beveled to further add to its beauty. Mounted with two No. 7605DP Bronze-Green *Personal-Point* desk pens, each fitted with a No. 6 Gold Seal Interchangeable nib, in a choice of fourteen points.

No. 8135AX—*Illustrated*. ARGENTINE ONYX

*List Price:* \$62.50

No. 8135NX—*Pepparava* ONYX. Mounted with two No. 7607DP Rosewood desk pens

*List Price:* \$57.50

No. 8135M—*Portoro* (Black and Gold) Marble. Mounted with two No. 7604DI Black and Pearl desk pens

*List Price:* \$57.50

STATUETTES AND TROPHIES

(For Illustration see pages 64-65)

*Prices include mounting on base*

- W-11 Gopher, Putty, Bronze..... \$10.00
- W-12 Basketball, Bronze..... \$10.00
- W-13 Bowler, Bronze..... \$10.00
- W-14 Runner, Bronze..... \$10.00
- W-31 Waltham Clock, Gold Plated..... \$35.00
- W-30 Puma, Oxidized Brass..... \$5.00
- W-29 Elephant, Bronze..... \$25.00
- W-33 Arched, Artistic, Bronze..... \$20.00
- W-58 Gopher, Drive, Bronze..... \$10.00
- W-60 Name Plate, Silver..... \$ 2.00
- W-59 Name Plate, Bronze..... \$ 2.00
- W-64 Name Plate, Gold Filled..... \$ 2.00

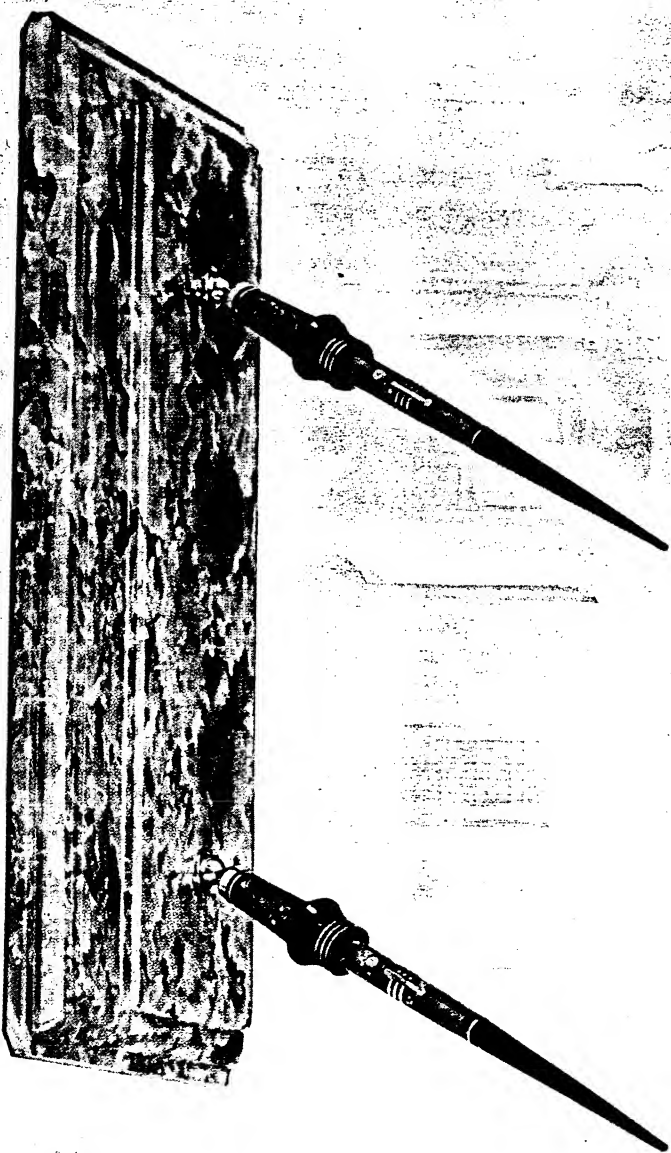
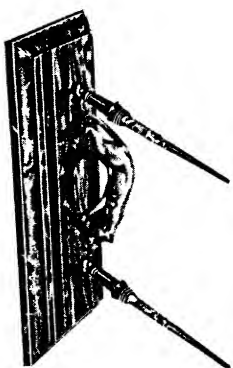

PEDRARA ONYX



PORTORO MARBLE



ARGENTINE ONYX

Above is actual reproduction of base material that may be obtained for set shown on this page.

**WAHL - EVERSHARP**

**WAHL-EVERSHARP Fountain Pen Desk Set** shown here with base of Portoro (Black and Gold) Marble, measuring approximately 8" x 13". Set is mounted with two No. 7604DP Black and Pearl *Personal-Paint Desk Pen*, each fitted with No. 6 Gold Seal Interchangeable nib, in a choice of fourteen points.

- No. 815M - *Illustrated*, Portoro (Black and Gold) Marble *List Price: \$45.00*
  - Code: TWERG*
  - No. 815NX - Pedrara Onyx Mounted with two No. 7607DP Rosewood desk pens *List Price: \$45.00*
  - Code: TAONX*
  - No. 815AX - ARGENTINE ONYX Mount, set with two No. 7605DP Bronze desk pens *List Price: \$45.00*
  - Code: ARDEL*
- STATUETTES AND TROPHIES**  
*(For Illustration see pages 64-65)*  
*Prices include mounting on base*
- W-11 Goller, Putter, Bronze..... \$10.00
  - W-12 Basketball, Bronze..... \$10.00
  - W-13 Bowler, Bronze..... \$10.00
  - W-14 Runner, Bronze..... \$10.00
  - W-31 Waltham Clock, Gold Plated..... \$25.00
  - W-30 Puma, Oxidized Brass..... \$5.00
  - W-29 Elephant, Bronze..... \$5.00
  - W-55 Arcselle, Antique Bronze..... \$25.00
  - W-58 Goller, Driver, Bronze..... \$25.00
  - W-60 Name Plate, Silver..... \$9.00
  - W-59 Name Plate, Bronze..... \$2.00
  - W-64 Name Plate, Gold Filled..... \$2.00

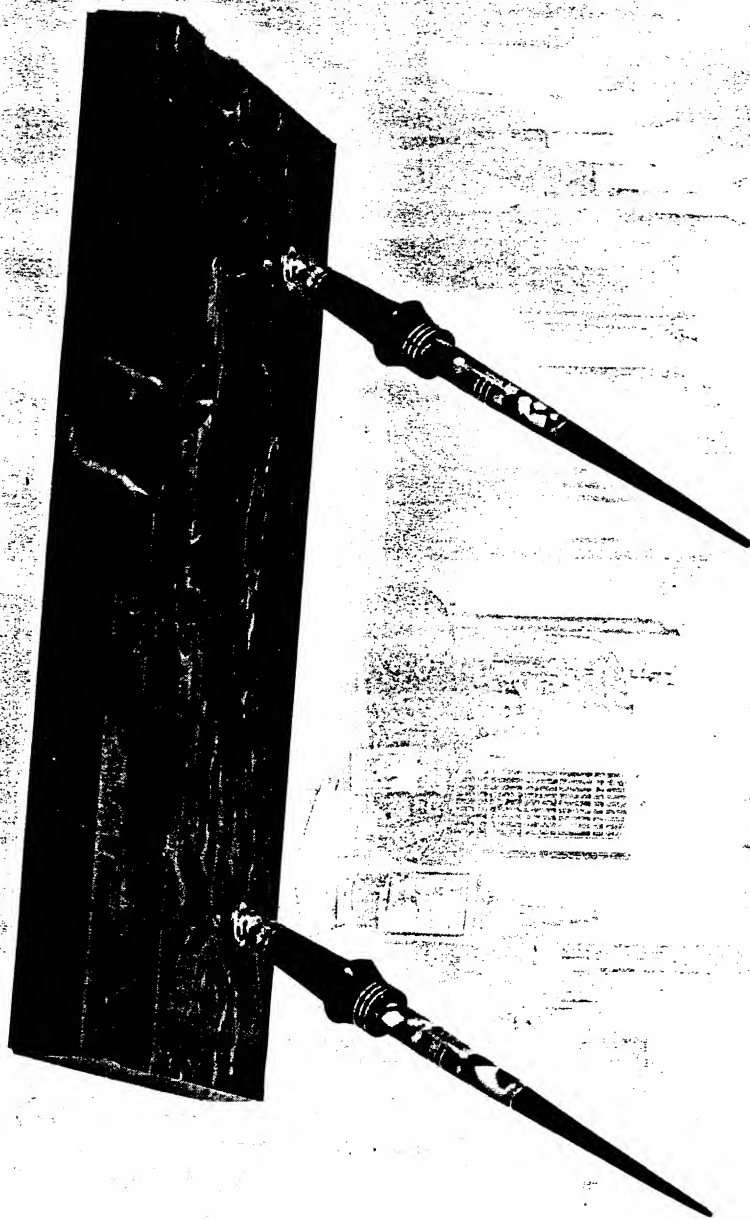

**PEDRARA ONYX**

**PORTORO MARBLE**

**ARGENTINE ONYX**

Above is actual reproduction of base material that may be obtained for set shown on this page.

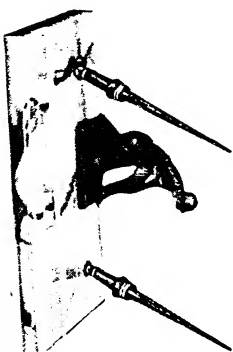

WALH-EVERSHARP

"SMART" is this oval base set—cut from beautiful Pedrara Onyx. The base has large pin scoop and measures approximately 6" x 12". Mounted with two No. 76071DP Rosewood Personal-Point Pens, each fitted with No. 6 Gold Seal Interchangeable nib. Nibs in Personal-Point Desk Pens may be interchanged with Personal-Point Pocket Pens whenever necessary.

No. 612NXO—Illustrated. PEDRARA ONYX

Code: UN0XP

List Price: \$35.00

No. 612AXO—ARGENTINE ONYX. Beautiful green with traces of red. Mounted with two No. 7605DP Bronze-Green desk pens

Code: UN0SK

List Price: \$40.00

STATUETTES AND TROPHIES

Applicable to these sets

(For Illustrations see pages 64-65)

Prices include mounting on base

- W-56 Golfer, Putter, Bronze..... \$ 5.00
- 3073 Elephant, Bronze..... \$17.50
- SE-4 Elephant, Imitation Bronze..... \$ 5.00
- W-52 Van Sicken Clock, Gold Plated..... \$25.00
- W-19 Golfer, Driver, Bronze..... \$ 8.75
- W-20 Football, Bronze..... \$ 8.75
- W-21 Basketball, Bronze..... \$ 8.75
- W-22 Runner, Bronze..... \$ 8.75
- W-23 Baseball..... \$ 8.75
- 3081 Reichert Dog, Bronze..... \$15.50
- W-60 Name Plate, Silver..... \$ 2.00
- W-69 Name Plate, Bronze..... \$ 2.00
- W-64 Name Plate, Gold Filled..... \$ 2.00

No. 612MO—PORTORO MARBLE. Two desk pens No. 7604DP.  
Code: UN0FY List Price: \$35.00

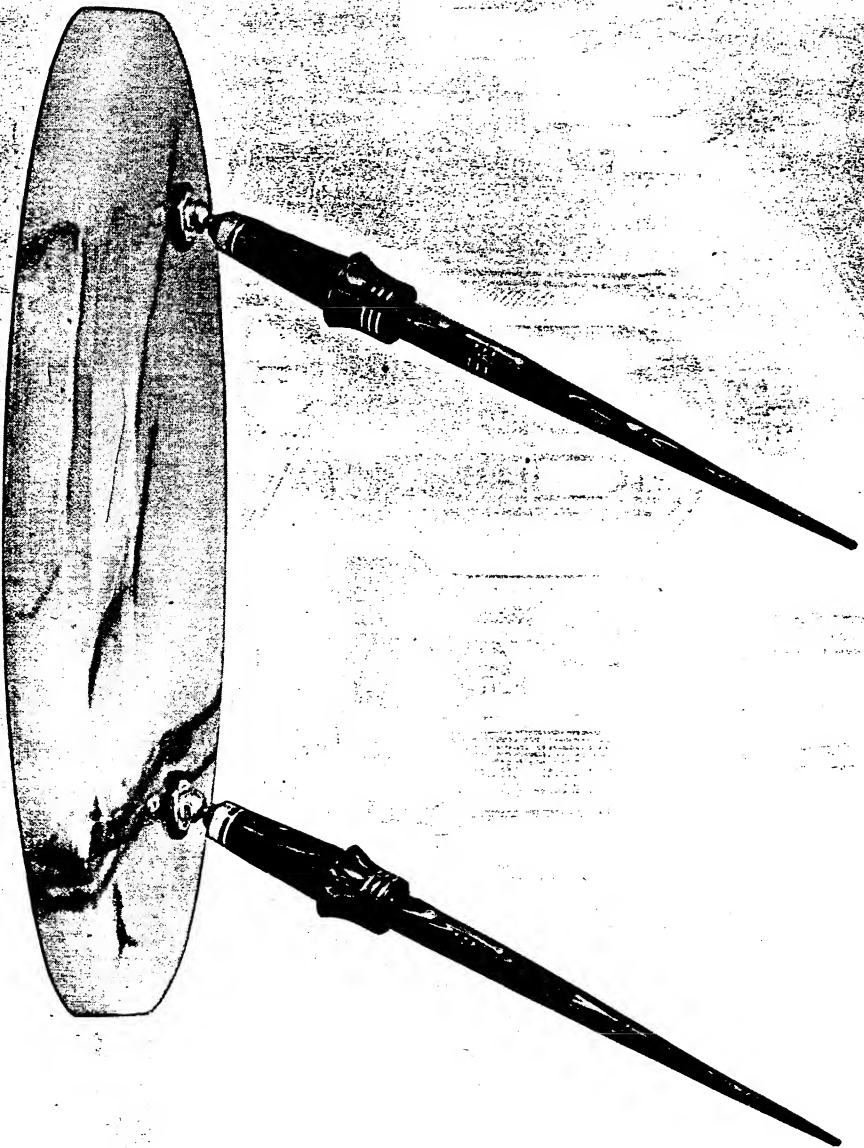
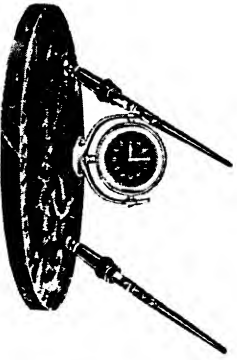

PEDRARA ONYX

PORTORO MARBLE

ARGENTINE ONYX

Above is actual reproduction of base material that may be obtained for set shown on this page.

WAHL-EVERSHARP

**EXECUTIVE Fountain Pen Desk Set** with base of Argentine Onyx. An added beauty for any desk—a utility wherever fountain pens are used for writing. Executives will welcome this set—one pen for blue ink and one for red.

Base measures approximately 6" x 12". Mounted with two No. 7605DP Bronze-Green *Personal-Point Desk Pens*, each having No. 6 Gold Seal interchangeable nib. Nibs in *Personal-Point Desk Pens* may be interchanged with *Personal-Point Pocket Pens* whenever necessary.

No. 612AX—*Illustrated*. ARGENTINE ONYX  
*List Price:* \$40.00  
 No. 612NX—Pedrara Onyx. Mounted with two No. 7607DP Rosewood desk pens  
*List Price:* \$55.00  
 No. 612M—Portoro Marble. Mounted with two No. 7608DP Black and Pearl desk pens  
*List Price:* \$55.00

STATUETTES AND TROPHIES

- Applicable to these sets  
 (For illustrations see pages 64-65)  
*Prices include mounting on base*
- W-56 Gaffer Putter, Bronze..... \$ 5.00
  - 3075 Elephant, Bronze..... \$17.50
  - SE-4 Elephant, Inlaid on Bronze..... \$ 5.00
  - W-32 Van Stieken Clock, Gold Plated..... \$25.00
  - W-19 Gaffer Driver, Bronze..... \$ 8.75
  - W-20 Football, Bronze..... \$ 8.75
  - W-21 Baseball, Bronze..... \$ 8.75
  - W-22 Runner, Bronze..... \$ 8.75
  - W-23 Baseball..... \$ 8.75
  - 3081 Reichert Dog, Bronze..... \$15.50
  - W-60 Name Plate, Silver..... \$20.00
  - W-59 Name Plate, Bronze..... \$ 2.00
  - W-64 Name Plate, Gold Filled..... \$ 2.00

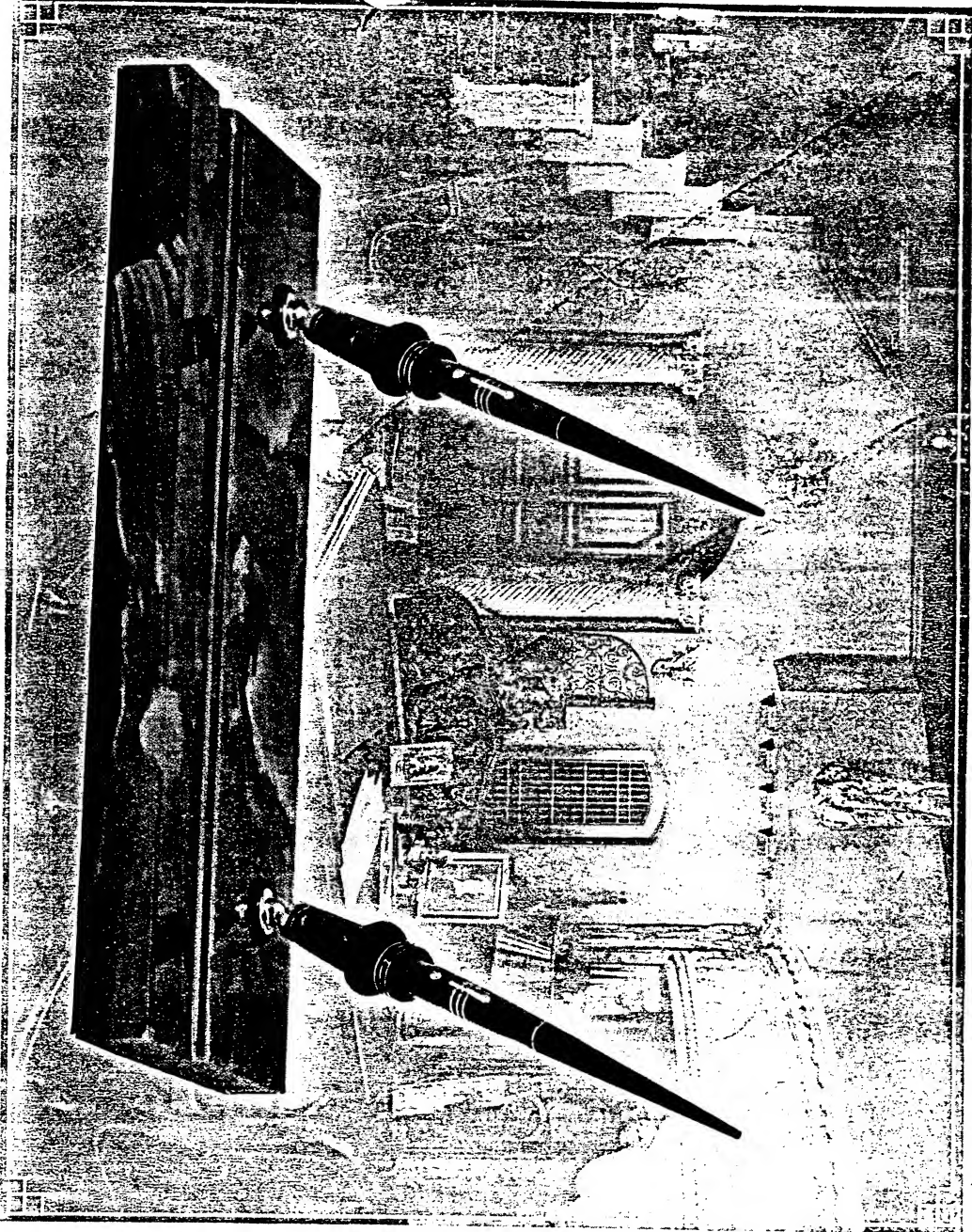

PEDRARA ONYX



PORTORO MARBLE



ARGENTINE ONYX

Above is actual reproduction of base material that may be obtained for set shown on this page.

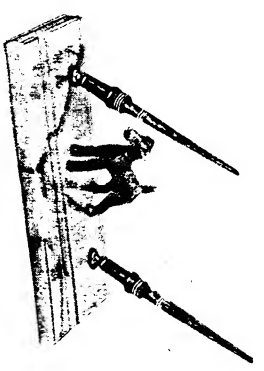



**WAHL - EVERSHPAR**

A PRACTICAL set for either office or home. The base is Pedrara Onyx and measures approximately 6" x 6". Mounted with two No. 7407DP Rosewood *Personal-Point Desk Pens*, each fitted with No. 4 Gold Seal Interchangeable nib in either Manifold, Signature or Flexible. Point selection need no longer prevent a desk set sale. The *Personal-Point Pen* takes care of that. The customer selects his point—it is instantly placed in the desk pens to make a complete Personal desk set.

No. 66NX4 - Illustrated. PEDRARA ONYX  
*List Price: \$22.50*  
 Code: SP1RX

No. 66M4 - Portoro Marble (Black and Gold). Mounted with two No. 7412DP Jade Green desk pens  
 Code: SP2RX *List Price: \$22.50*

**NAME AND MONOGRAM PLATES**

*Prices include mounting on base*  
 W-62 Name Plate Silver..... \$1.50  
 W-61 Name Plate Bronze..... \$1.50  
 MP-5 Shield, Satin Gold Plate..... \$1.50  
 MP-6 Arrowhead, Satin Gold Plate..... \$1.50  
 MP-7 Oval, Satin Gold Plate..... \$1.50

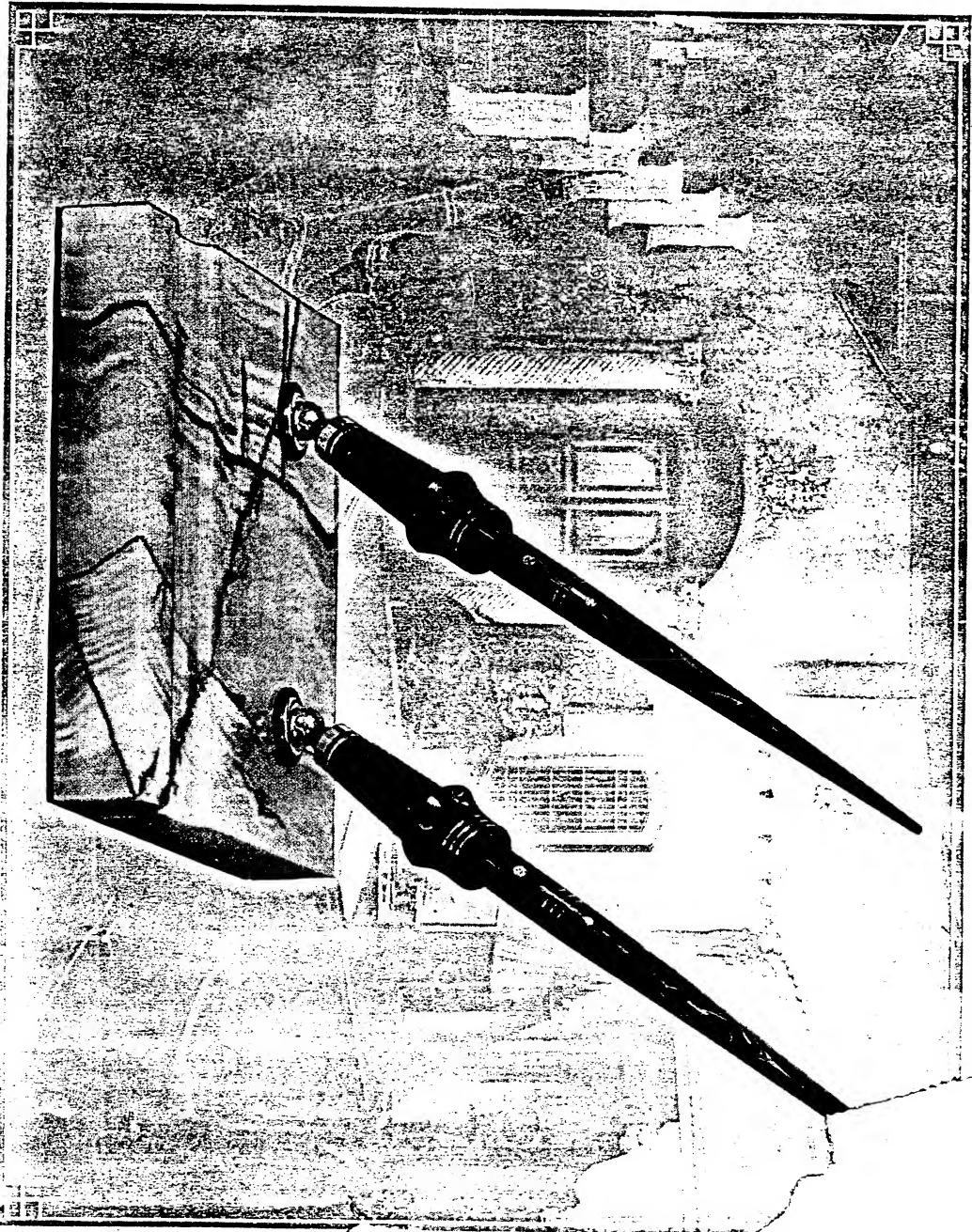
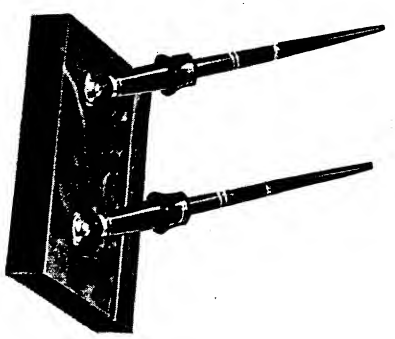

**PORTORO MARBLE**

Above is actual reproduction of base material that may be obtained for set shown on this page.



**PEDRARA ONYX**

**WAHL - EVERS HARP**

The set shown here might be rightly named the Junior Executive Set. The base is cut from Portoro (Black and Gold) Marble, measuring approximately 4 1/2" x 8". Mounted with two No. 7413DP Coral Personal Point Desk Pens, each fitted with nib. For the customer's selection there is a choice of fourteen points, each instantly and permanently placed. Points in pocket pens are interchangeable with those in desk pens whenever necessary. The beauty of the set need not be sacrificed to supply the proper point.

No. 458M2 - Illustrated, Portoro Marble (Black and Gold)

Code: UNCR

List Price: \$22.50

**STATUETTES AND TROPHIES**

(For Illustration see pages 64-65)

Prices include mounting on base

- SG-63 Goller, Driver, Bronze..... \$5.00
- SD-2 Wahl Dog, Antique Brass Patina..... \$3.00
- W-62 Name Plate, Silver..... \$1.50
- M-61 Name Plate, Bronze..... \$1.50
- MP-5 Shield, Satin Gold Plate..... \$1.50
- MP-6 Arrowhead, Satin Gold Plate..... \$1.50
- MP-7 Oval, Satin Gold Plate..... \$1.50



**PORTORO MARBLE**

Above is actual reproduction of base material that may be obtained for set shown on this page.

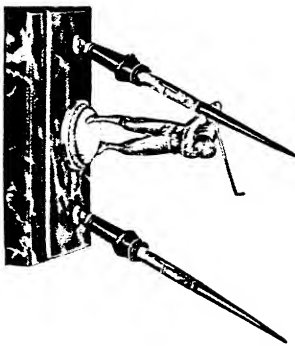

A PARTICULAR set for "Particular People," designed for either office or home use. This set is especially adapted to the home desk because the oval Pedrara Onyx base measures only about 4" x 7" and can be used where space is limited. Mounted with one No. 7413DP Coral Personal-Point Desk Pen, fitted with No. 4 Gold Seal Interchangeable nib. Whenever necessary the points in Personal-Point Pocket Pens may be interchanged with those in Personal-Point Desk Pens. This added convenience will promote the sale of higher priced desk sets because the customer can always be supplied with a point that exactly suits his individual style.

No. 47NXO—Illustrated. PEDRARA ONYX Code: WBSH *List Price:* \$18.00

**NAME AND MONOGRAM PLATES**

*Price includes mounting on base*

W-64 Name Plate, Gold Filled.....	\$2.00
MP-5 Shield, Satin, Gold Plate.....	\$1.50
MP-6 Arrowhead, Satin Gold Plate.....	\$1.50
MP-7 Oval, Satin Gold Plate.....	\$1.50

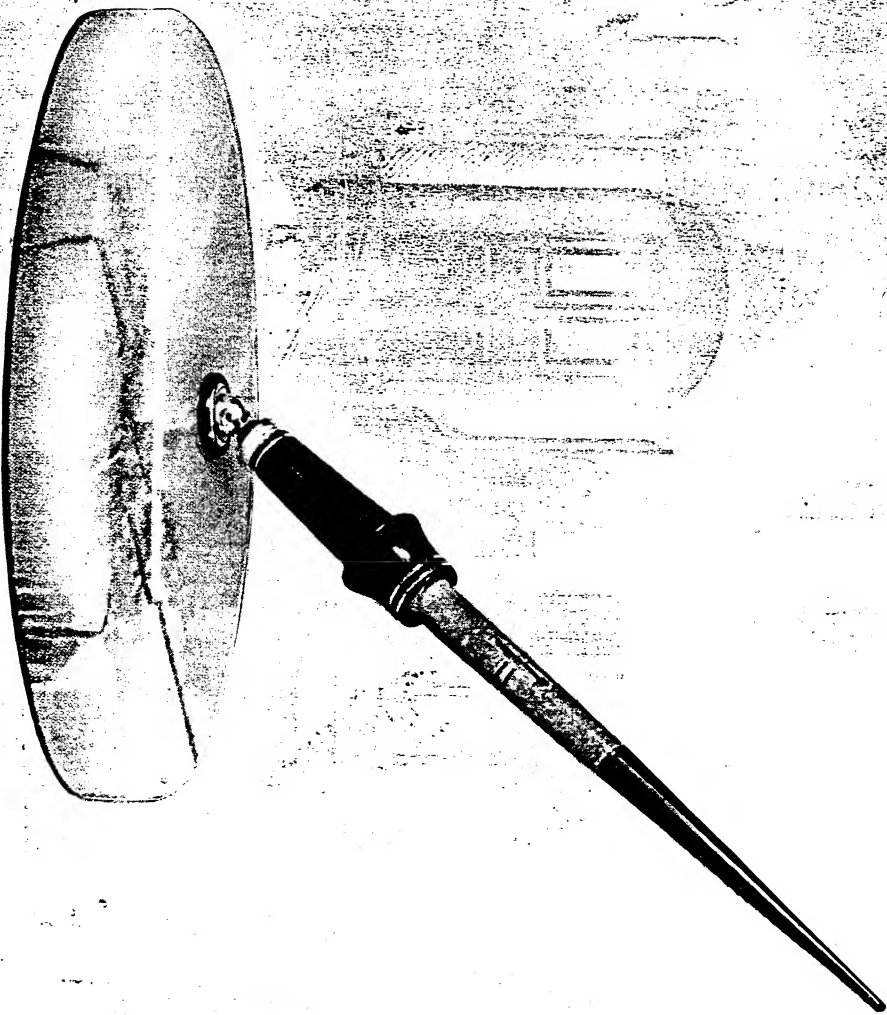
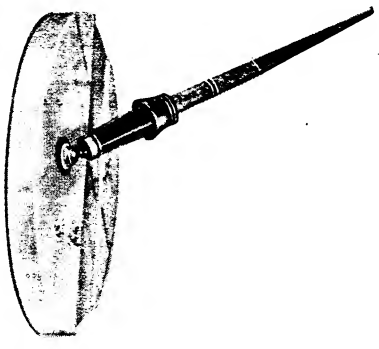

PEDRARA ONYX  
Above is actual reproduction of base material that may be obtained for set shown on this page.

**WAHL - EVERSHARP**

**A** FOUNTAIN PEN DESK SET combining beauty and utility where only one pen is needed. Ideal for the home desk or hotel and club registration desk. The base is Black Carrara Glass, measuring approximately 4" x 7".

Mounted with one No. 7604DP Black and Pearl Personal-Point Desk Pen, fitted with No. 6 Gold Seal Interchangeable nib. Personal-Point in Desk Pens and Pocket Pens are Interchangeable.

No. 476RG—*Illustrated*. Black Glass  
Code: ubounm Lid Price: \$18.00

No. 476AX—Angegrüßte Onyx Mounted with one No. 7605DP Bronze Green desk pen  
Code: ubemmp Lid Price: \$18.00

No. 476NX—Pedrara Onyx Mounted with one No. 7607DP Rosewood desk pen  
Code: spocn Lid Price: \$15.00

No. 476M—Porrono (black and gold) Marble Mounted with one No. 7612DP Jade Green desk pen  
Code: twuzt Lid Price: \$15.00

**NAME AND MONOGRAM PLATES**

Applicable to any Desk Set  
Price includes mounting on base

W-64 Name Plate, Gold Filled.....	\$2.00
MP-5 Shield, Satin Gold Plate.....	\$1.50
MP-6 Arrowhead, Satin Gold Plate.....	\$1.50
MP-7 Oval, Satin Gold Plate.....	\$1.50

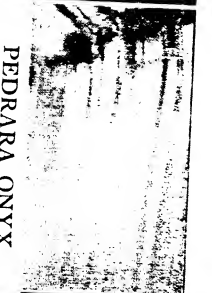
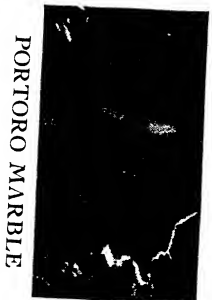
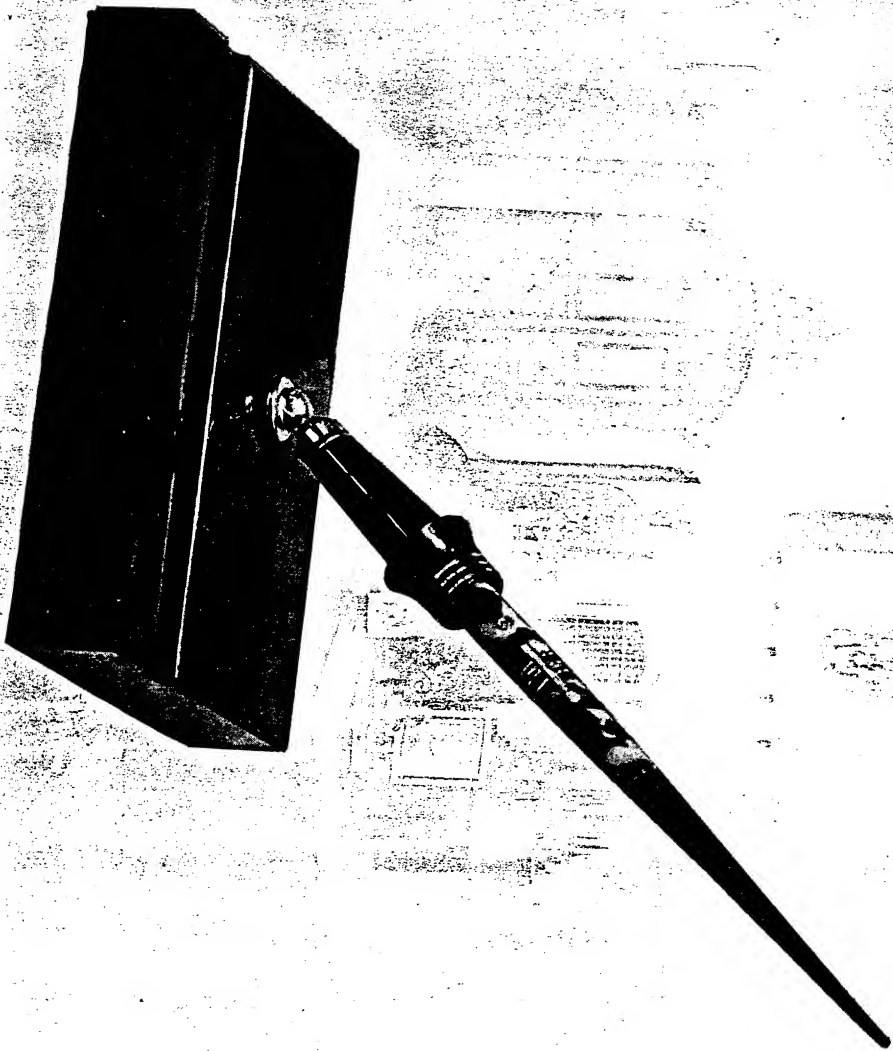

PORTORO MARBLE

PEDRARA ONYX

CARRARA GLASS

ARGENTINE ONYX

Above is actual reproduction of base material that may be obtained for set shown on this page.

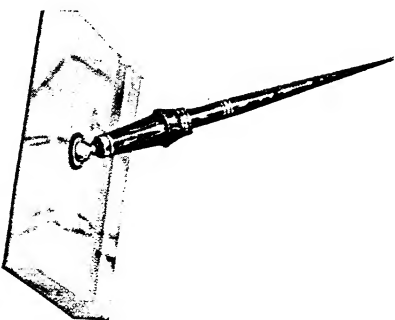

WAHL - EVERSHARP

A DISTINCTIVE set for either office or home desk. Base has special shape with depression that can be used as clip or pin scoop, or as an ash tray. The Argentine Onyx base is approximately 5 1/2" x 6 1/2". Mounted with one No. 7205DDP Bronze-Green Desk Pen. As a home set this beautiful Onyx base will add much in convenience and dignity to the home desk.

No. X56AX - Illustrated. ARGENTINE ONYX

Code: ucetz

List Price: \$17.50

STATUETTES AND TROPHIES

(For Illustration see pages 64-65)

Prices include mounting on base

- SG-63 Colfer, Driver, Bronze.....\$3.00
- SD-2 Wolf Dog, Antique Brass Patina.....\$3.00
- MP-5 Shield, Satin Gold Plate.....\$1.50
- MP-6 Arrowhead, Satin Gold Plate.....\$1.50
- MP-7 Oval, Satin Gold Plate.....\$1.50

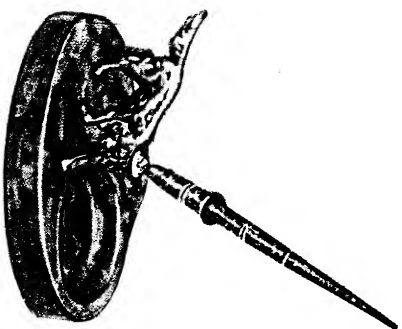

ARGENTINE ONYX  
Above is actual reproduction of base material that may be obtained for set shown on this page.

WAHL-EVERSHARP

**D**ISTINCTIVELY DIFFERENT, this Argentine Onyx pear-shaped set with depression for ash tray or for pin scoop. Measures approximately 4½" x 5". Mounted with one No. 7205DP Bronze-Green desk pen. For correspondence as well as other home needs the modern day housewife and daughters will find this set not only an article of unusual value but a real home decoration. The home desk demands that feminine touch so well displayed in this set.

No. X54AX - *Illustrated*, ARGENTINE ONYX  
*Color version* *List Price*: \$15.00

**MONOGRAM PLATES**  
 Applicable to any Desk Set  
 (For Illustrations see page 65)  
*Prices include mounting on base*

MP-5 Shield, Satin Gold Plate.....	\$1.50
MP-6 Arrowhead, Satin Gold Plate.....	\$1.50
MP-7 Oval, Satin Gold Plate.....	\$1.50

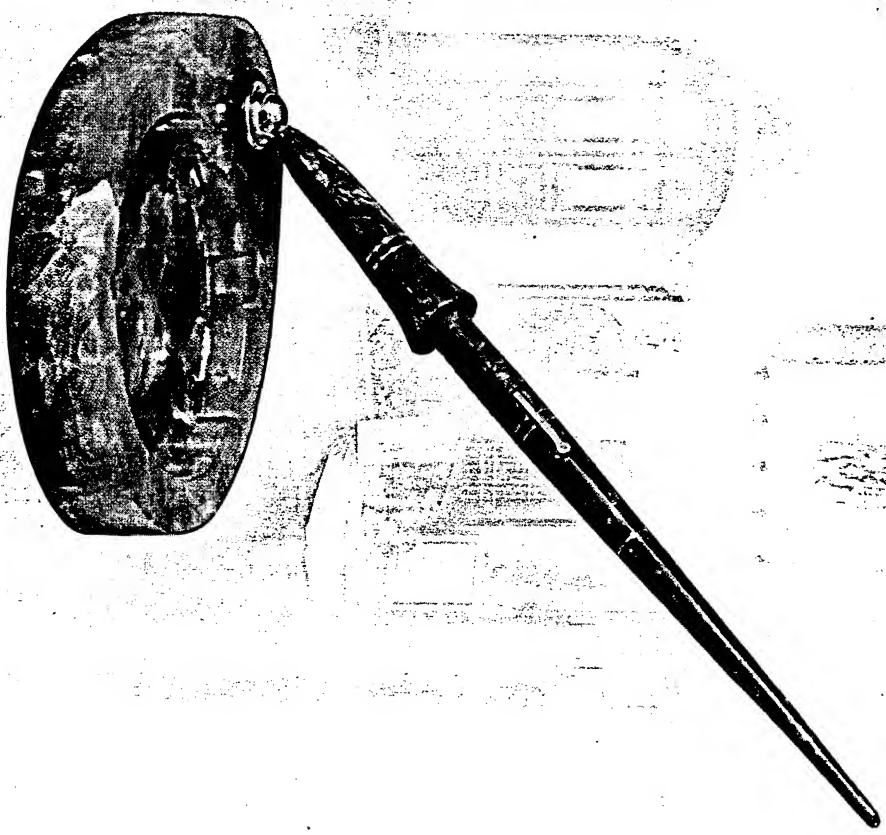

**ARGENTINE ONYX**  
 Above is actual reproduction of base material that may be obtained for set shown on this page.

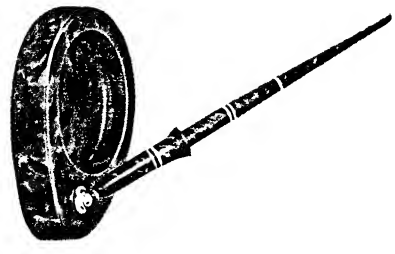

## WAHL - EVERSHARP

A BEAUTIFUL set to adorn Mi-lady's spinet desk and especially adaptable to home use. The base is Argentine Onyx and measures approximately 4" x 4". Beveled corners and depression for pins or clips. Mounted with one No. 7205DP Bronze-Green desk pen. Unusual creations strike the keynote of success in WAHL-EVERSHARP fountain pen desk set manufacture. Further proof of this is found in the set illustrated on this page.

No. X44AX—*Illustrated.* ARGENTINE ONYX

*Code:* ucck *List Price:* \$13.50

### STAPPETTES

Adaptable to this set

(For Illustrations see page 65)

*Prices include mounting on base*

- SK-1 Wahl Cat, Antique Brass Patina...\$2.50
- W-36 Clown Bulldog, Bronze.....\$2.50
- MP-6 Shield, Satin Gold Plate.....\$1.50
- MP-6 Arrowhead, Satin Gold Plate.....\$1.50
- MP-7 Oval, Satin Gold Plate.....\$1.50

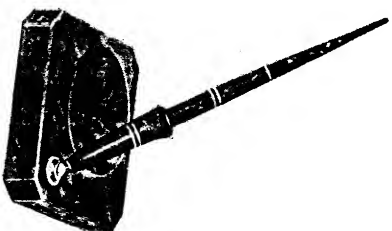

### ARGENTINE ONYX

Above is actual reproduction of base material that may be obtained for set shown on this page.

**WAHL - EVERSHARP**

"HOME SET" attractively decorated. Base is Pedrara Onyx and measures approximately 5 1/2" x 6". Has one wide pencil groove. Mounted with one No. 72151DP Coral desk pen and one gold plated letter bracket. The home-maker invariably has good taste for her library. This set will fill the home writing equipment need in the most exacting home. Both style and beauty have been combined to make this unusual set.

No. 556NNXB—*Illustrated*. Pedrara Onyx

*List Price: \$12.50*

No. 556AX—ARGENTINE ONYX. Mounted with one No. 7205DDP Bronze-bracket green desk pen. Has no letter bracket

*List Price: \$12.50*

**MONOGRAM PLATES**

Applicable to any Desk Set  
(For Illustrations see page 65)

- MP-5 Shield, Satin Gold Plate.....\$1.50
- MP-6 Arrowhead, Satin Gold Plate.....\$1.50
- MP-7 Oval, Satin Gold Plate.....\$1.50

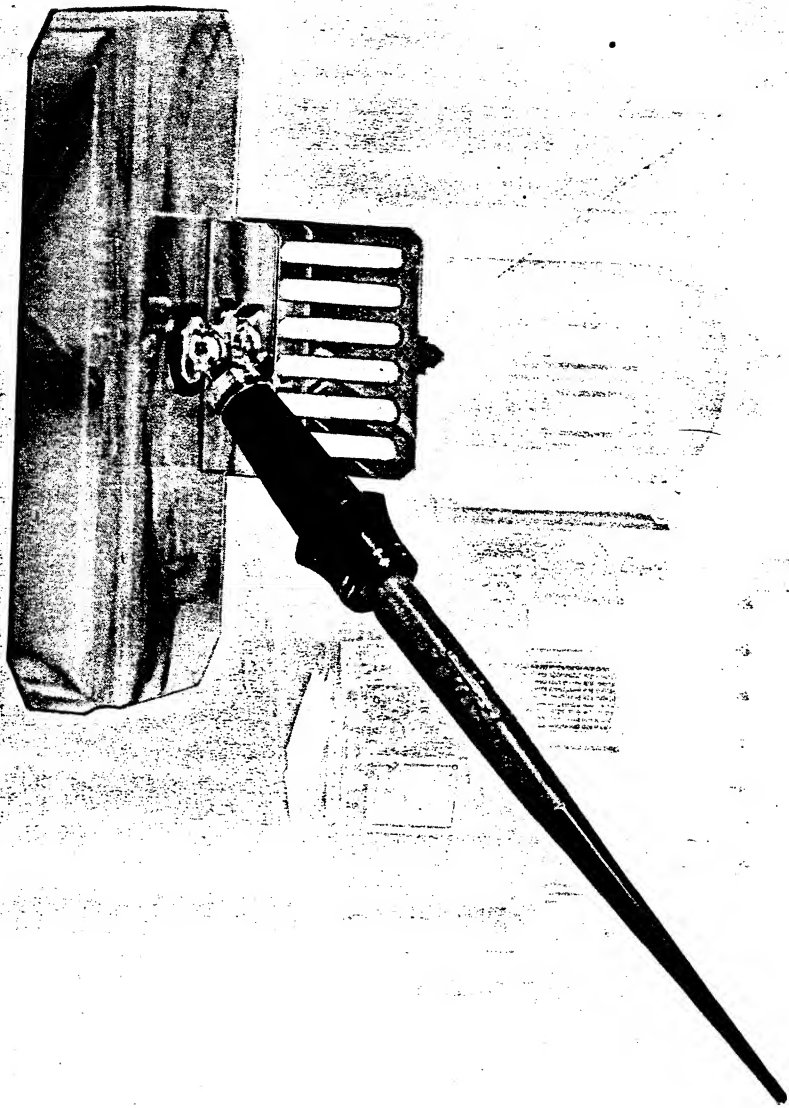

**ARGENTINE ONYX**

Above is actual reproduction of base material that may be obtained for set shown on this page.

**PEDRARA ONYX**

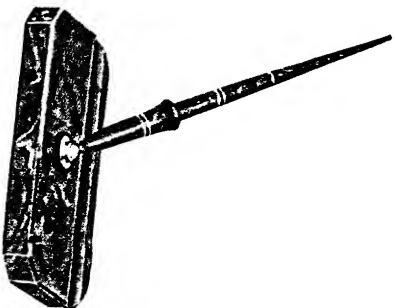



**WHL - EVERSHARP**

A PRACTICAL set for home or office. Requires little space on the desk and combines grace and utility. Base is Pedrara Onyx and measures approximately 4" x 4". Mounted with one No. 7407DPP Rosewood *Personal-Point Desk Pen*, fitted with No. 4 Gold Seal Interchangeable nib in a choice of fourteen points. Here is a set that will serve a two-fold purpose—a convenience in the home and a necessity in the office. The Interchangeable nib makes possible the selection of a point to suit the lightest feminine hand or the heaviest masculine signature.

No. 44NX - *Illustrated* - PEDRARA ONYX  
*Code:* 500BK *List Price:* \$10.00

No. 44M - PORTORO (Black and Gold) Marble, Mounted with one 7410DPP black desk pen  
*Code:* 5188B *List Price:* \$10.00

**NAME AND MONOGRAM PLATES**

*Price includes mounting on base*

W-64 Name Plate, Gold Filled.....	\$2.00
MP-5 Shield, Satin Gold Plate.....	\$1.50
MP-6 Arrowhead, Satin Gold Plate.....	\$1.50
MP-7 Oval, Satin Gold Plate.....	\$1.50

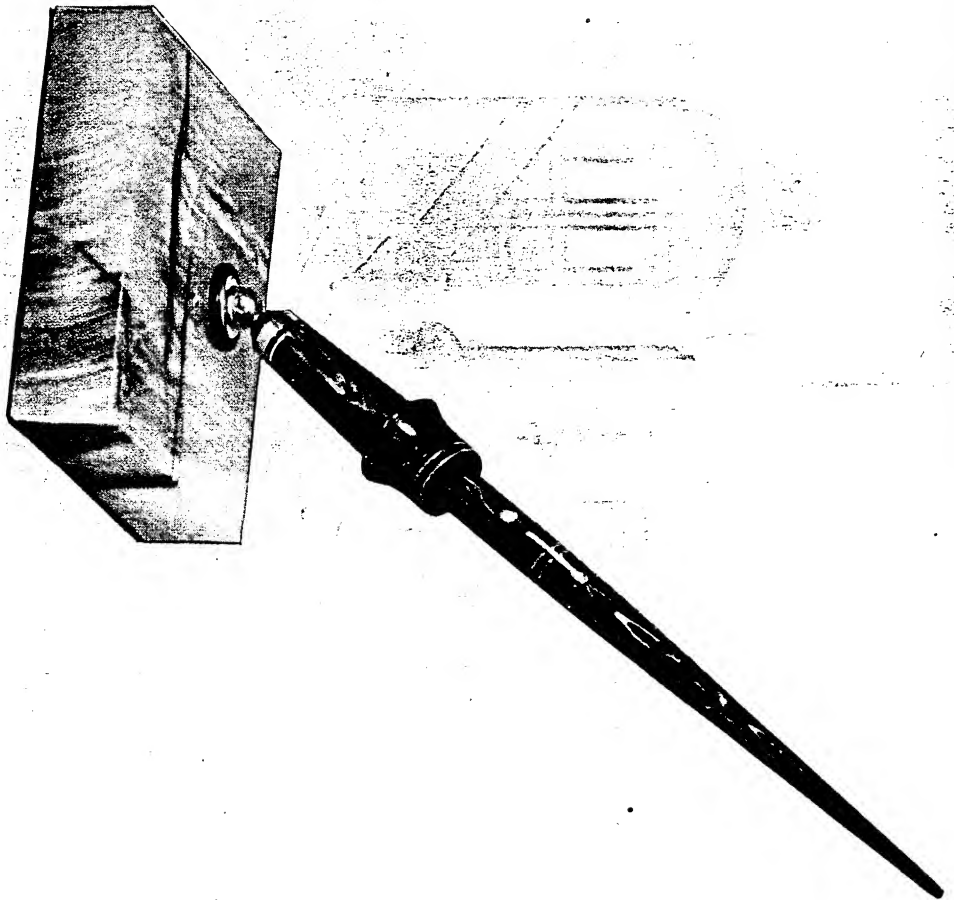
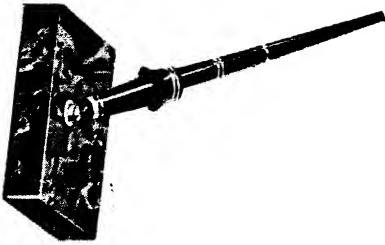

**PORTORO MARBLE**

Above is actual reproduction of base material that may be obtained for set shown on this page.



**PEDRARA ONYX**

**WAHL - EVERS HARP**

LADIES' set made especially for home use. No longer need the "lady of the house" use an old-fashioned steel pen and messy ink stand. The base is Black Carrara Glass with beveled corners. It measures approximately 3 1/2" x 4" and is mounted with one No. 7204DP Black and Pearl desk pen and one gold plated letter bracket.

No. 354BG - *Illustrated*, Black Carrara

Glass.

Code: UMZD

*List Price:* \$100.00

No. 354AX - Argentine Onyx. Mounted with one No. 7215DP Coral desk pen.

Code: TWESD

*List Price:* \$100.00

No. 354NX - Pedrara Onyx. Mounted with one No. 7207DP Rosewood desk pen.

Code: TWAVX

*List Price:* \$100.00

No. 354M - Portoro (Black and Gold) Marble. Mounted with one No. 7212DP Jade Green desk pen.

Code: TWECX

*List Price:* \$100.00

**MONOGRAM PLATES**

Applicable to any Desk Set

(For Illustrations see page 65)

*Prices include mounting on base*

- MP-5 Shield, Satin Gold Plate..... \$1.50
- MP-6 Arrowhead, Satin Gold Plate..... \$1.50
- MP-7 Oval, Satin Gold Plate..... \$1.50

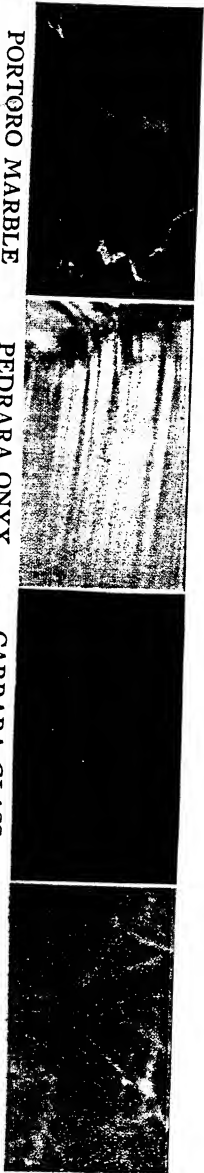
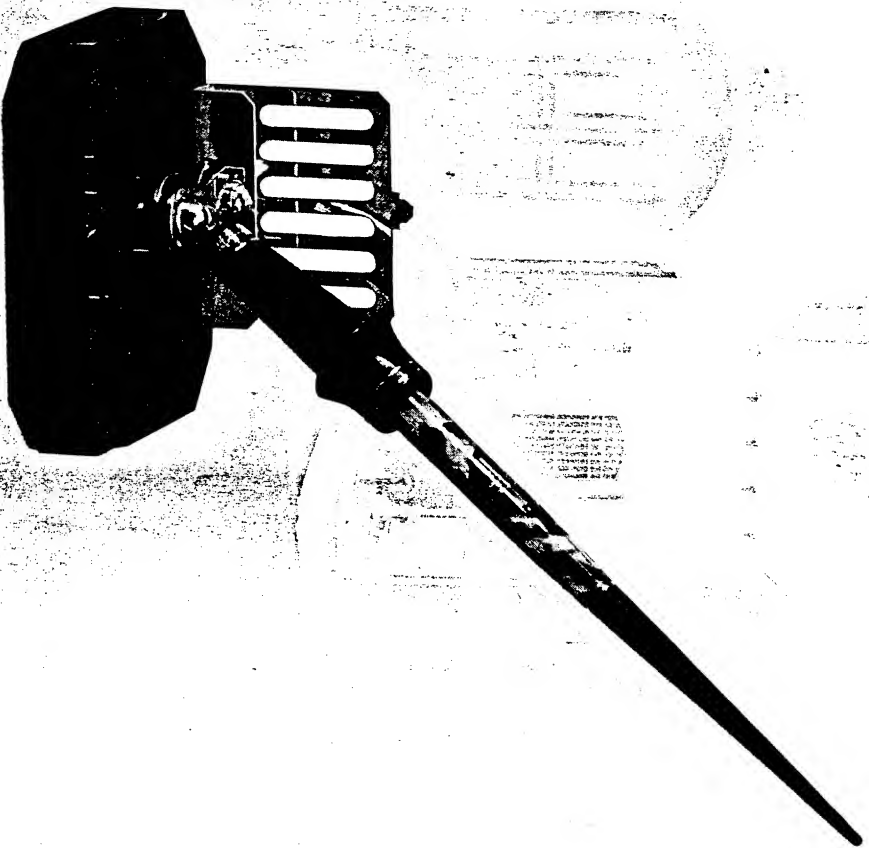

**PORTORO MARBLE**

**PEDRARA ONYX**

**CARRARA GLASS**

**ARGENTINE ONYX**

Above is actual reproduction of base material that may be obtained for set shown on this page.

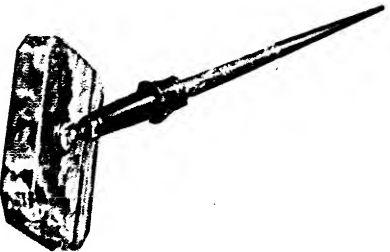

**WAHL - EVERSHARP**

An appropriate set for the spinet desks in the smartest homes. Requires little space, which makes it particularly adapted to home libraries. The base is Portoro (black and gold) Marble and measures approximately  $3\frac{1}{2}''$  x  $3''$ . Mounted with one No. 7212DP Jade Green desk pen. The set shown here as well as those described are particularly adaptable to home use.

No. 353M—*Illustrated*. PORTORO MARBLE  
Code: UVAZZ List Price: \$8.50

No. 353NX—PEDRARA ONYX. Mounted with one No. 7207DP Rosewood desk pen  
Code: UBAWX List Price: \$8.50

No. 353AX—ARGENTINE ONYX. Mounted with one No. 7205DP Bronze-Green desk pen  
Code: UBOHW List Price: \$9.00

No. 353BG—BLACK CARRARA GLASS. Mounted with one No. 7204DP Black and Pearl desk pen  
Code: UBOHK List Price: \$8.50

**MONOGRAM PLATES**

Applicable to any Desk Set  
(For Illustrations see page 65)

*Prices include mounting on base*

MP-5 Shield, Satin Gold Plate.....\$1.60  
MP-6 Arrowhead, Satin Gold Plate.....\$1.50  
MP-7 Oval, Satin Gold Plate.....\$1.50

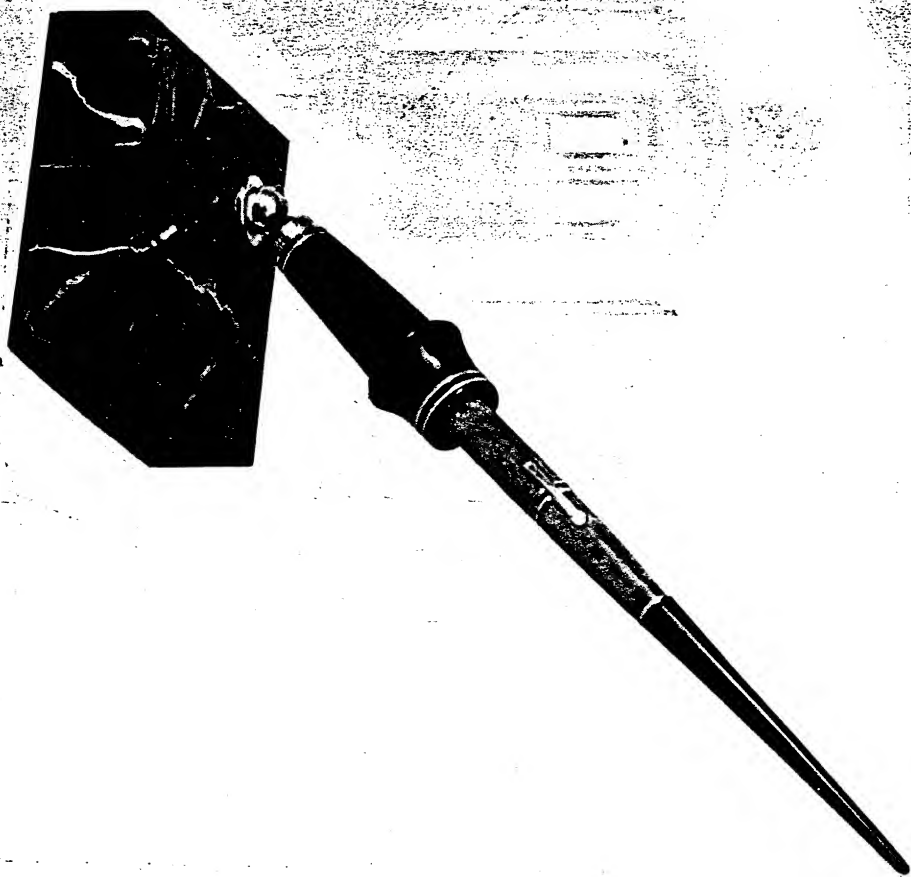
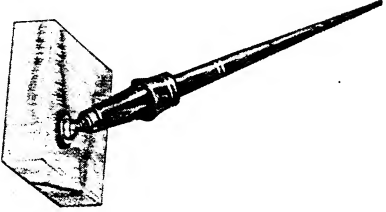

PORTORO MARBLE

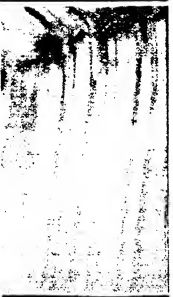

PEDRARA ONYX



CARRARA GLASS



ARGENTINE ONYX

Above is actual reproduction of base material that may be obtained for set shown on this page.

**WAHL - EVERS HARP**

UTILITY sets for the office employee as well as for the home. Those who desire the advantages of modern day writing equipment at low cost will welcome these sets. Those who desire the best in desk equipment at minimum cost will appreciate the value in these sets. Black and Gold marble has that beauty that lasts as only marble will.

No. 25RM2—*Illustrated*. Portoro Marble. Round base, approximately 5" diameter. Mounted with one No. 7215DP Coral desk pen.  
Code: sumd *List Price: \$7.50*

No. 25M2—*Illustrated*. Portoro Marble. Base approximately 2 1/2" square. Mounted with one No. 7210DP Black desk pen.  
Code: sumk *List Price: \$7.50*

**MONOGRAM PLATES**

Applicable to any Desk Set  
(For Illustrations see page 65)  
*Prices include mounting on base*

MP-5: Shield, Satin Gold Plate.....	\$1.50
MP-6: Arrowhead, Satin Gold Plate.....	\$1.50
MP-7: Oval, Satin Gold Plate.....	\$1.50

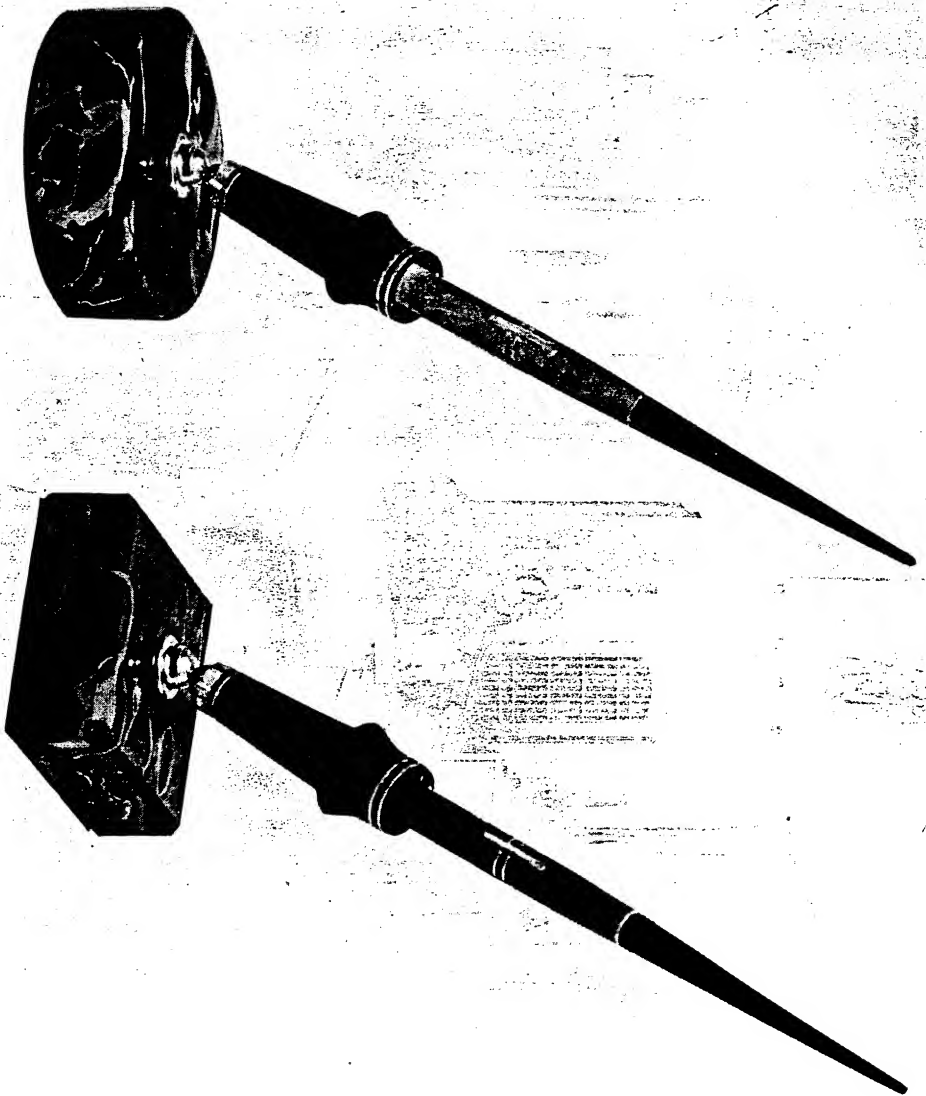

**PORTORO MARBLE**

Above is actual reproduction of base material that may be obtained for set shown on this page.

**PEDRARA ONYX**

**I**NEXPENSIVE—modern—attractive—serviceable, all describe the two utility desk sets shown here. Beauty and quality are all combined in these "petite" sets, suitable for home or office use.

No. 25RNX - *Illustrated*. PEDRARA ONYX. Round base approximately 3" diameter. Mounted with one No. 7212DP Jade Green desk pen  
*Code: sturd* *Lid Price: \$7.50*

No. 25NX - *Illustrated*. PEDRARA ONYX. Base approximately 2 1/2" square. Mounted with one No. 7207DP Rosewood desk pen  
*Code: stood* *Lid Price: \$7.50*

**MONOGRAM PLATES**

Applicable to any Desk Set  
(For Illustrations see page 65)  
*Prices include mounting on base*  
MP-5 Shield, Satin Gold Plate.....\$1.50  
MP-6 Arrowhead, Satin Gold Plate.....\$1.50  
MP-7 Oval, Satin Gold Plate.....\$1.50

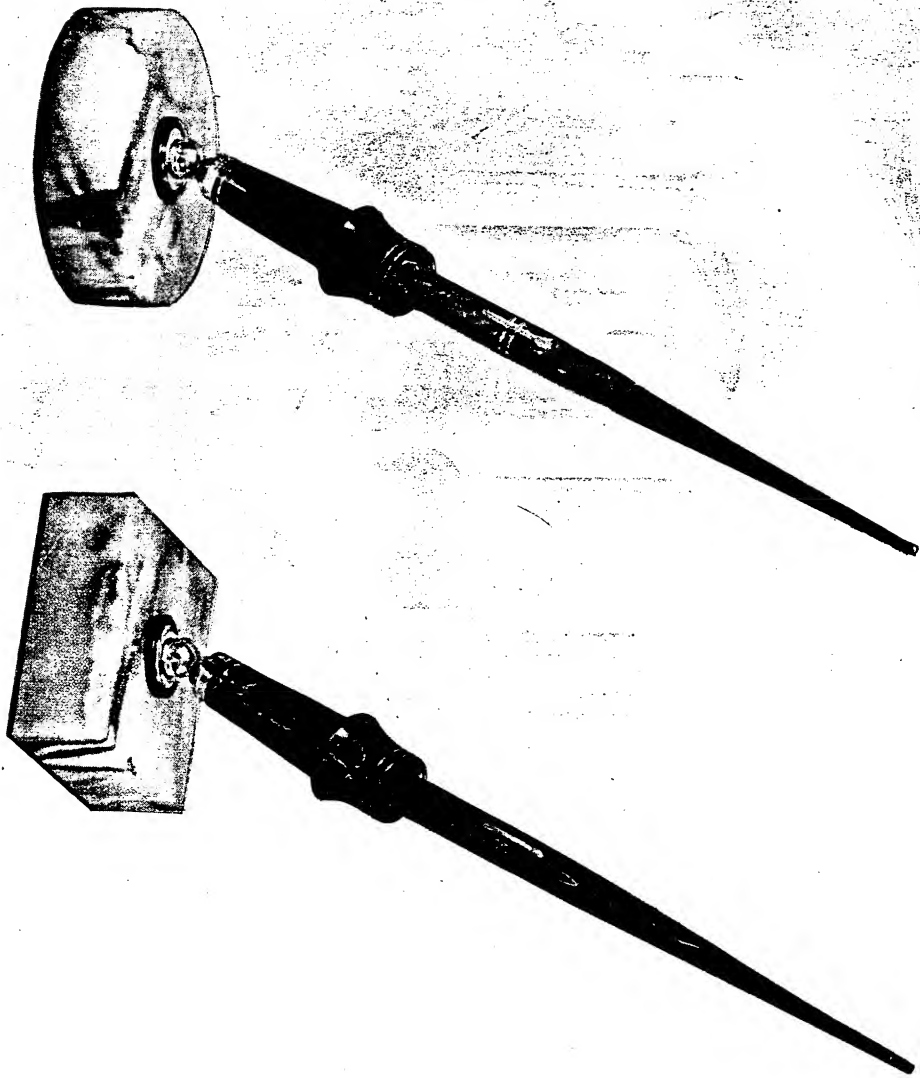

**PORTORO MARBLE**



**PEDRARA ONYX**

Above is actual reproduction of base material that may be obtained for set shown on this page.

WAHL-EVERSHARP

The sets shown on this page are made to appeal directly to the feminine taste. These latest creations for the home desk are the result of months of study of the desires of Mlady for her home desk equipment.

No. 280AXR - ARGENTINE ONYX

Base. Approximately 5" diameter. Mounted with one No. 7215DP Coral desk pen.

Code: AC2EP List Price: \$8.00

No. 528AX - ARGENTINE ONYX.

Approximately 2 1/8" x 5". Mounted with one No. 7215DP Coral desk pen.

Code: ACSAR List Price: \$8.00

MONOGRAM PLATES

Applicable to any Desk Set (For Illustrations see page 65)

Prices include mounting on base

MP-5 Shield, Satin Gold Plate..... \$1.50

MP-6 Arrowhead, Satin Gold Plate..... \$1.50

MP-7 Oval, Satin Gold Plate..... \$1.50

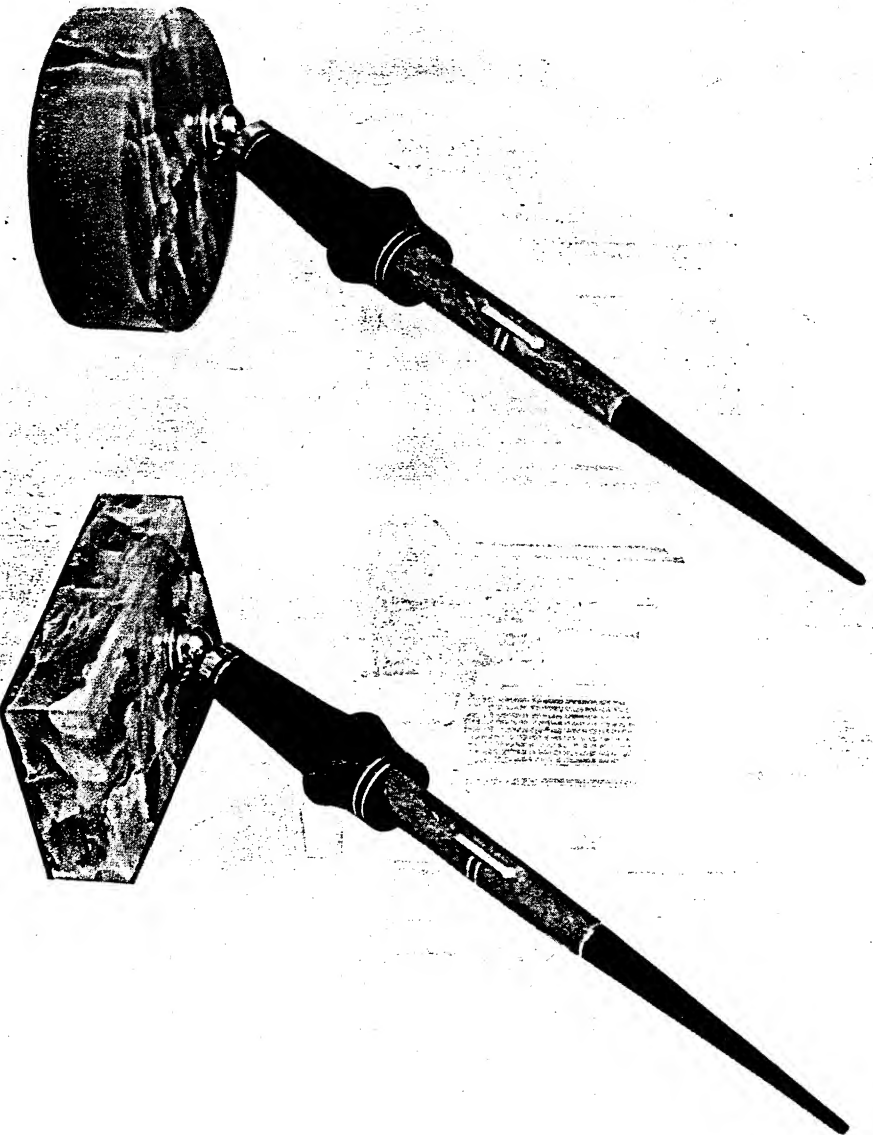

ARGENTINE ONYX

Above is actual reproduction of base material that may be obtained for set shown on this page.



UTILITY sets for home or office use. Particularly suitable for business gifts. Names and other information can be engraved on plates and attached to these bases. These sets are "business getters" for industrial concerns, banks, bond houses, and insurance companies. Industrial concerns who demand a really worth while gift for their customers will do well in selecting these sets.

No. 3727—Pressed Steel Base, bronze finish, 3 3/4" diameter and mounted with one No. 8208DP Walnut pen  
 Code: SNUNZ Lid Price: \$6.00

No. 4129—CONVEX METAL BASE, covered with embossed brown steerhide. Approximately 4" diameter and mounted with one No. 7201DP Lignum Vitae pen  
 Code: SUOKT Lid Price: \$7.50

**MONOGRAM PLATES**

Applicable to any Desk Set  
 (For Illustrations see page 66)  
 Prices include mounting on base  
 MP-5 Shirdl, Satin Gold Plate.....\$1.50  
 MP-6 Arrowhead, Satin Gold Plate.....\$1.50  
 MP-7 Oval Satin Gold Plate.....\$1.50

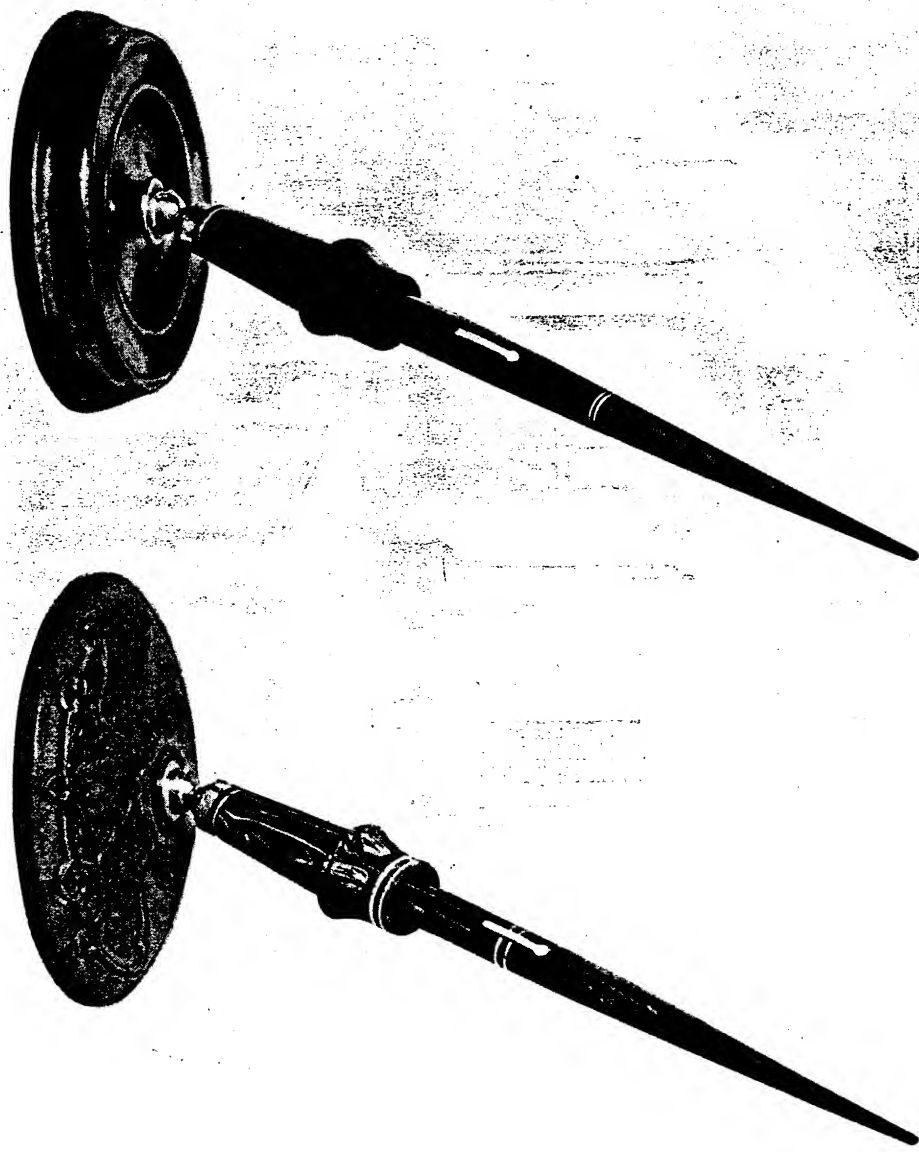

**FRENCH BRONZE FINISH**

Above is actual reproduction of base material that may be obtained for set shown on this page.



**LEATHER**

**WAHL - EVERS HARP**

STRICTLY a utility set for office workers, factory superintendents, billing and shipping clerks, correspondents, and all those who use a pen for desk work. The base is of stamped steel in black enamel finish, with two red enamel pin trays. Because these trays are easily removed, they may be used for ash trays as well. Base is  $4\frac{1}{2}$ " x  $6\frac{1}{2}$ " and mounted with one No. DP82RT desk pen with red taper. There is an almost unlimited field for sales of desk sets in this price field. Utility is combined with attractiveness to make this set a leader.

No. 4655BWR—BLACK AND RED STEEL AND  
STEEL *List Price: \$7.50*

**MONOGRAM PLATES**

Applicable to any Desk Set  
(For Illustrations see page 65)

*Prices include mounting on base*

MP-5 Shield, Satin Gold Plate..... \$1.50  
MP-6 Arrowhead, Satin Gold Plate..... \$1.50  
MP-7 Oval, Satin Gold Plate..... \$1.50

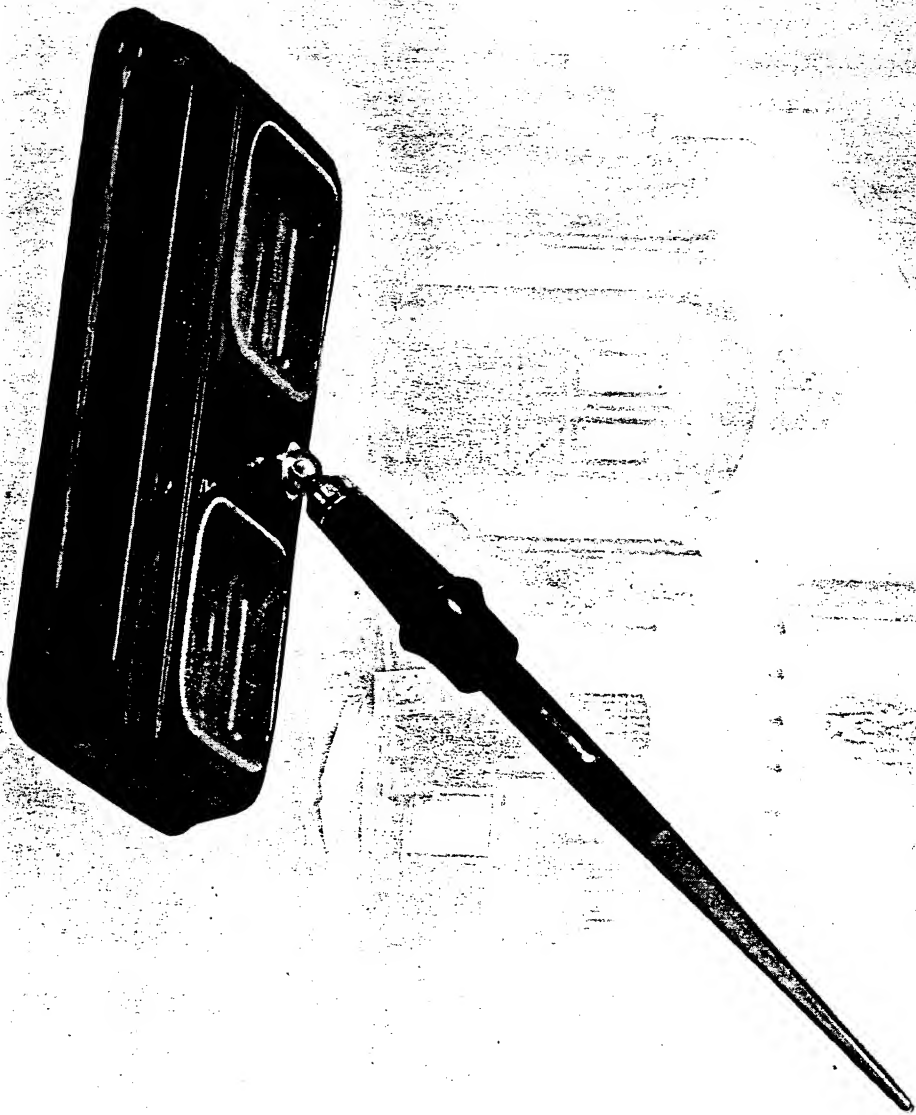

**BLACK-RED ENAMEL**  
Above is actual reproduction of base material that may be obtained  
for set shown on this page.

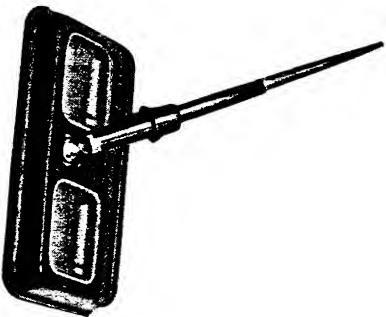



WAHL-EVERSHARP

HERE is a new utility set for home or office use. Base is Moss Crystal, deep green in color, measuring approximately 4" x 6". Cut in half-moon shape with two depressions for pins and clips—also wide pencil groove. Mounted with one No. 7210DP Jet Black desk pen, fitted with No. 2 nib. Those who are looking for the latest in style and attractiveness for the writing desk will appreciate the unusual value of this set. The Moss Crystal base radiates the quality found only in the best merchandise.

No. 4625XG - Illustrated. Moss  
CRYSTAL

Code: ADMED List Price: \$7.50

MONOGRAM PLATES

Applicable to any Desk Set

(For Illustrations see page 65)

Prices include mounting on base

- MP-5 Shield, Satin Gold Plate.....\$1.50
- MP-6 Arrowhead, Satin Gold Plate.....\$1.50
- MP-7 Oval, Satin Gold Plate.....\$1.50

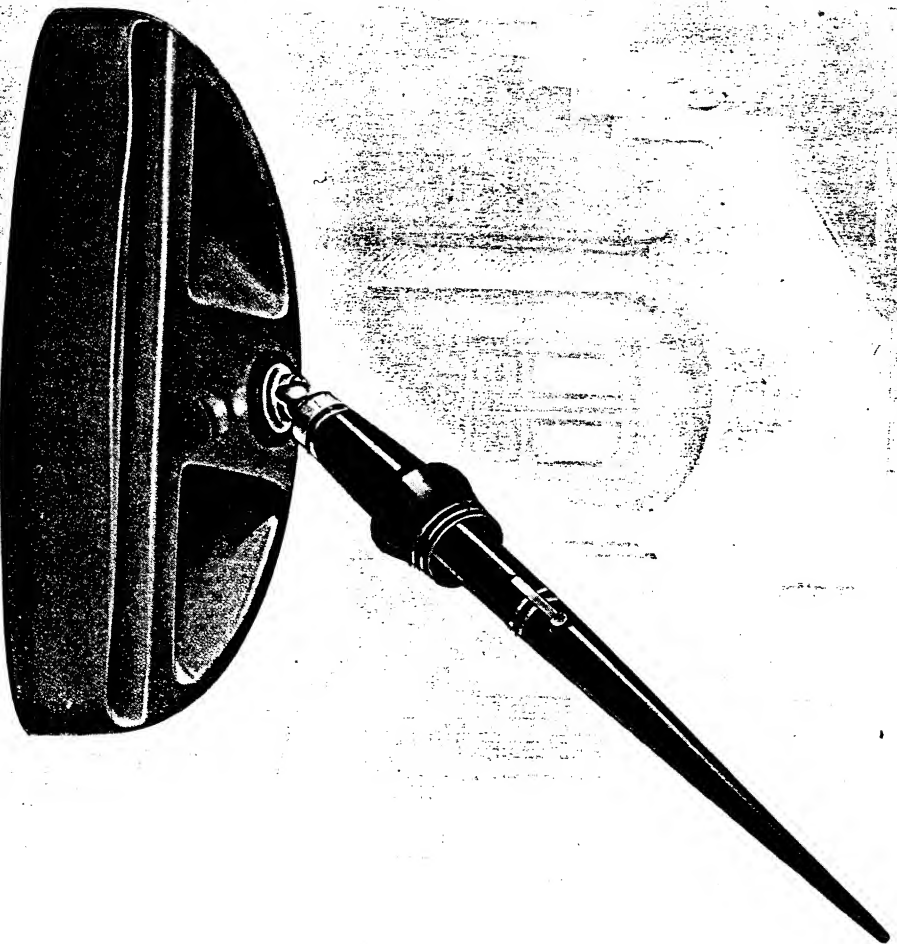
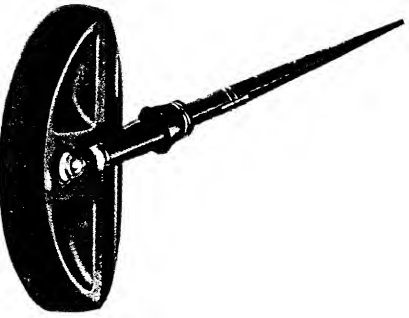

AND now we pass from the Desk Set Department where these writing instruments of beauty and utility start their journey to all parts of the civilized world. WAHL-EVERSHARP Fountain Pen Desk Sets supply the writing need for every kind of desk work. The

Personal-Point Desk Pen with the Interchangeable nib makes personal nib selection possible. No longer is it necessary for the executive, clerk, or home desk to worry along with the old-fashioned dip pen and messy ink well. The wide selection of sets shown in this catalog will answer every customer's need.

**WAHL - EVERSHARP**

These WAHL-EVERSHARP *Desk Pencils* have been styled after the famous perfectly balanced WAHL-EVERSHARP *Desk Fountain Pens*. With practically every desk set, there is use for one of these desk pencils made in six popular colors that may be used with a wide variety of bases and desk pens. These EVERSHARPS have the same perfect mechanism found in all EVERSHARP *Packet Pencils*—the first mechanical pencil to use thin lead.

No. 4007H - Rosewood Desk Pencil

*Code:* SPONZ *List Price:* \$3.50

No. 4010H - Jet Black Desk Pencil

*Code:* SLAF *List Price:* \$3.50

No. 4005H - Bronze-Green Desk Pencil

*Code:* UKIFK *List Price:* \$4.00

No. 4001H - Lignum Vitae Desk Pencil

*Code:* TOFPI *List Price:* \$3.50

No. 4012H - Jade Green Desk Pencil

*Code:* TOIMP *List Price:* \$3.50

No. 4004H - Black & Pearl Desk Pencil

*Code:* UKIZP *List Price:* \$4.00

*When desk pencil unit is wanted on desk set bases add suffix "DT" to desk set symbol. Units add \$2.50 to list price.*

4007 H

4010 H

4005 H

4001 H

4012 H

4004 H

# WAHL - EVERSHARP

A STATUETTE mounted on a WAHL-EVERSHARP *Fountain Pen Desk Set* will add a touch of beauty and individuality. The trophy statuettes illustrated on this page are applicable to many of the larger bases. For convenience in selecting and ordering these attractive statuette combinations, several are listed that will harmonize with the wide range of desk sets. Please refer to desk set pages 39 to 62 inclusive.

- W-11 - *Golfer, Putter, large*  
Bronze.....\$10.00
  - W-12 - *Basketball Player, large*  
Bronze.....\$10.00
  - W-13 - *Baseball, large*  
Bronze.....\$10.00
  - W-14 - *Runner, large*  
Bronze.....\$10.00
  - W-58 - *Golfer, Driver, large*  
Bronze.....\$10.00
  - W-19 - *Golfer, Driver, medium*  
Bronze.....\$ 8.75
  - W-20 - *Football Player, medium*  
Bronze.....\$ 8.75
  - W-21 - *Basketball Player, medium*  
Bronze.....\$ 8.75
  - W-22 - *Runner, medium*  
Bronze.....\$ 8.75
  - W-23 - *Baseball Pitcher, medium*  
Bronze.....\$ 8.75
  - SG-63 - *Golfer, Driver, small*  
Bronze.....\$ 5.00
- Prices Include Mounting on Base*



W-14 - BRONZE  
Approximately 6 1/2" high  
W-22 - BRONZE  
Approximately 5 1/2" high



W-15 - BRONZE  
Approximately 5 3/4" high



W-58 - BRONZE  
Approximately 6 1/2" high  
W-19 - BRONZE  
Approximately 5 1/2" high  
SG-63 - BRONZE  
Approximately 4" high



W-20 - BRONZE  
Approximately 5 1/2" high



W-11 - BRONZE  
Approximately 6 1/2" high  
W-56 - BRONZE  
Small Golfer Putter  
\$5.00



W-23 - BRONZE  
Approximately 5 1/2" high

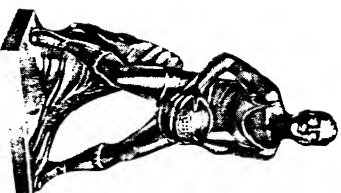

W-12 - BRONZE  
Approximately 6 1/2" high  
W-21 - BRONZE  
Approximately 5 1/2" high

**WAHL - EVERS HARP**

A SELECTION of statuettes to meet the most exacting tastes are pictured on this page.



SD-2 - ANTIQUE BRASS PATINA  
Approximately 5" wide, 2" high  
3081 - GENUINE BRONZE  
Approximately 5" wide, 2" high



W-30 - OXIDIZED BRASS  
Approximately 6" wide, 2 1/2" high



W-36 - BRONZE  
Approximately 1 1/2" high



W-33 - ANTIQUE GOLD BRONZE  
Approximately 4 1/2" wide, 4" high



SK-1 - ANTIQUE BRASS PATINA  
Approximately 1 3/4" high

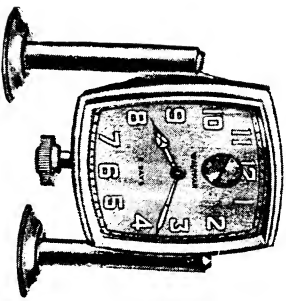

W-31 - GOLD PLATE  
Illustration approximately half size

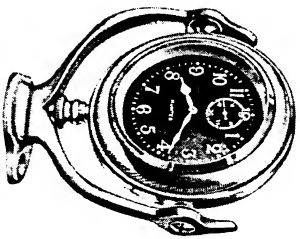

W-32 - GOLD PLATE  
Illustration approximately half size



W-29 - BRONZE  
Approximately 6" wide, 5" high  
3075 - BRONZE  
Approximately 4 1/2" wide, 3 3/8" high  
SE-4 - IMITATION BRONZE  
Approximately 4 1/4" wide, 2 3/8" high



MP-7



MP-6

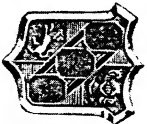

MP-5

MP-5, MP-6, MP-7 - SATIN GOLD PLATE  
Reproductions actual size

- SD-2 - Wain, Dog, medium Antique Brass Patina..... \$ 5.00
- 3081 - Dog, medium Genuine Bronze..... \$15.50
- W-33 - Airedale, large Antique Gold Bronze..... \$20.00
- W-30 - Puma, large Oxidized Brass..... \$ 5.00
- W-29 - Elephant, large Bronze..... \$25.00
- 3075 - Elephant, medium Bronze..... \$17.50
- SE-4 - Elephant, small Imitation Bronze..... \$ 5.00
- W-36 - Clown Dog, small Bronze..... \$ 2.50
- SK-1 - Wain, Cat, small Antique Brass Patina..... \$ 2.50
- W-31 - Waltham Clock, Gold Plate, 8 day, 7 jewel, pendant wind, green hands and figures..... \$35.00
- W-32 - Van Sicken Clock, Gold Plate, round case, swing support desk clock..... \$25.00
- MP-5 - Monogram Plate with Initials, Shield, Satin Gold Plate..... \$ 1.50
- MP-6 - Monogram Plate with Initials, Arrowhead, Satin Gold Plate..... \$ 1.50
- MP-7 - Monogram Plate with Initials, Oval, Satin Gold Plate..... \$ 1.50
- W-62 - Small Name Plate, Silver Not illustrated..... \$ 1.50
- W-61 - Small Name Plate, Bronze Not illustrated..... \$ 1.50
- W-60 - Medium Name Plate, Silver. Not illustrated..... \$ 2.00
- W-59 - Medium Name Plate, Bronze. Not illustrated..... \$ 2.00
- W-64 - Small Name Plate, 3 8" x 5", Gold Filled. Not illustrated..... \$ 2.00

Prices Include Mounting on Base

**MACHINE ENGRAVED NAMES**—  
Either individual names or firm names and addresses can be engraved on desk set bases in plain block type, letters filled in with a contrasting color enamel.

**FACSIMILE SIGNATURE REPRODUCTIONS**—An exact reproduction of any personal signature, filled in contrasting color on Marble or Onyx bases only.

**ETCHED OXIDIZED OR COLOR PLATES**—Reproduction of trademarks in outline or in colors—plates of bronze or brass. Samples of standard sized plates on request.

**GOLD FILLED PLATES OR WASHERS**—Plates of a size to conform to size of base, suitable for hand engraving personal names or presentation messages. Washers with  $\frac{3}{8}$ " rim to place under pen swivel for engraving.

**GOLD STAMPING ON LEATHER BASES**—Single names in plain block type, a different name on each base. Standard imprints in plain block type—the same imprint on all bases.

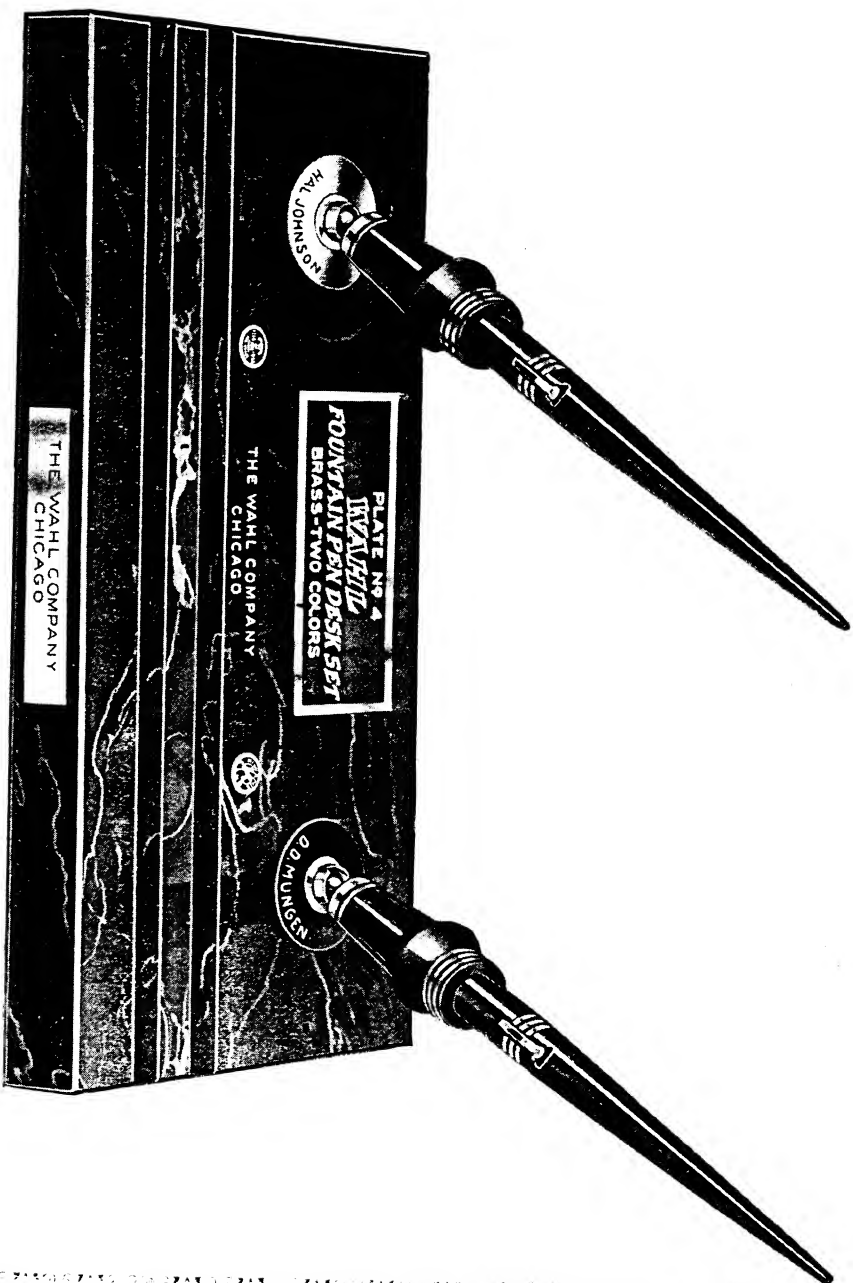

## Personalizing Wahl-Eversharp Fountain Pen Desk Sets

**WAHL-EVERSHARP Fountain Pen Desk Sets** stand supreme as personal and business gifts. Our skilled engravers have perfected numerous designs for enhancing the gift value of the Desk Set.

On this page we are listing a few of the many ways in which we can actually personalize the Desk Set and make it the gift of gifts!

Every set in our extensive line can be engraved or fitted with beautiful and dignified name plates. Christmas, birthday, wedding and anniversary gifts will be prized and valued beyond expectation if they are WAHL-

EVERSHARP Desk Sets tastefully engraved with the recipient's name.

Many business houses that are averse to presenting the usual advertising calendars, memo pads, etc., will welcome the opportunity to purchase desk sets imprinted with their trade-mark or business name. This is an advertising gift that will be appreciated and one that will continually act as a reminder of the donor.

Lack of space makes it impossible to outline every way in which the desk sets can be engraved. We shall be happy to furnish additional information upon request.

# WAHL - EVERSHARP

## Precious Metal Pens and Pencils



OREMOST among the finer writing instruments in the WAHL-EVERSHARP line is a complete selection of precious metal pens and pencils, both yellow and green gold, as well as Sterling. Each of these items is built to jeweler's precision because we feel the retail dealer today has a right to expect the manufacturer whose products he handles to keep those products abreast of the times, in keeping with the demands of his customers.

WAHL-EVERSHARP gave to the fountain pen and pencil industry the first precious metal writing instruments built on a practical basis, a merchandise writing tool because it filled a long felt consumer desire.

Even today there are those who prefer to carry a pen and pencil of precious metal, and because our dealers are looked upon to supply this highest type merchandise, we have shown a complete line in this catalog.

Certain practical advantages are found in these WAHL-EVERSHARP precious metal pens and pencils. Because of the mechanical construction,

although much smaller in size, the metal pen has an ink capacity equal or greater than any of the so-called "Jumbo" or "Oversize" composition pens sold over the counter. Among the superior features are the rolled metal threads, compact filling device, silver lined cap, exclusive EVERSHARP clip, and most important, the beautiful jewelry designs created by our own artists.

The EVERSHARPS to match these various pens in several different metals each contain the famous perfect EVERSHARP mechanism. Perhaps because EVERSHARP was the first mechanical pencil to use thin lead, accounts for its unrivaled popularity throughout the civilized world. Like all EVERSHARPS, these pencils contain everything a fine pencil should have—the patented rifle tip that made a mechanical pencil possible (it insures a tight lead), instant loading, extra lead magazine, exclusive pocket clip, and the great advantage of having all parts interchangeable.

On the pages that follow are colorful reproductions of these precious metal pens and pencils in a variety of styles, sizes and metals.

WHEN a really worth-while and practical gift is wanted, these Green or Yellow 14K Solid Gold WAHL-EVERSHARP Pens with the pencils, shown opposite, will bring joy and satisfaction to the recipient. A logical selection for those desiring something better.

No. 5291 W - 18K Solid Green Gold, Hand Engraved with No. 2 nib - Ladies' model with ring cap  
Code: A5291  
List Price: \$40.00

No. 5297 W - 18K Solid Green Gold, Diamond Design with No. 2 nib - Ladies' model with ring cap  
Code: MA5297  
List Price: \$35.00

No. 7297 C - 18K Solid Green Gold, Diamond Design, long model with clip and No. 2 nib  
Code: MA7297  
List Price: \$37.50

No. 7497 C - 18K Solid Green Gold, Diamond Design with No. 4 Personal Point/Interchangeable nib. Identified by the Gold Seal of quality  
Code: MA7497  
List Price: \$55.00

No. 7291 C - 18K Solid Green Gold, Hand Engraved with No. 2 nib, Long model with clip  
Code: A5291  
List Price: \$50.00

Precious Metal Combination Sets Packed in Special Gift Boxes.

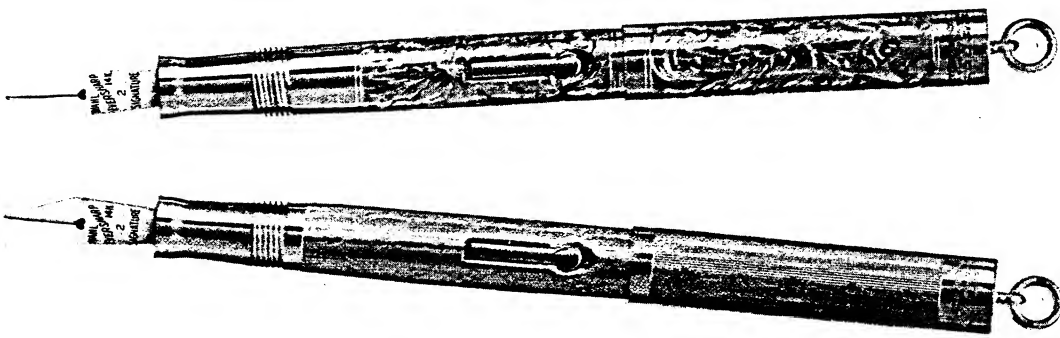

5291 W      5297 W

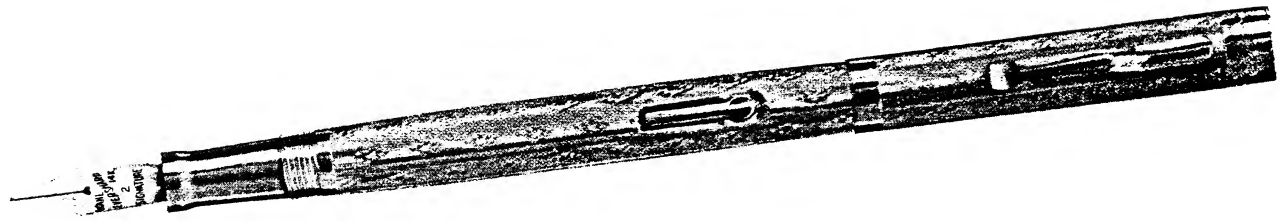

7297 C

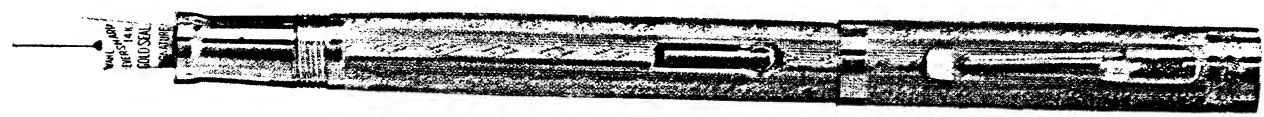

7497 C

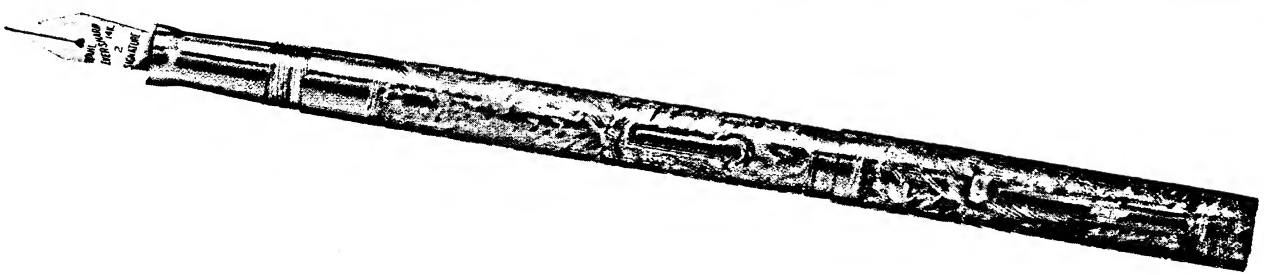

7291 C

WAHL - EVERSHARP

The Precious Metal EVERSHARPS shown here may be used to complete combination sets with the pens shown opposite. A WAHL-EVERSHARP Precious Metal pen and pencil set is a gift worth while.

No. 3091W - 18K Solid Green Gold, Hand Engraved, Ladies' model with ring cap

Code: ABANV

List Price: \$35.00

No. 3097W - 18K Solid Green Gold, Diamond Design, Ladies' model with ring cap

Code: ANNUH

List Price: \$28.00

No. 3097C - 18K Solid Green Gold, Diamond Design, Long model with clip

Code: ABBQG

List Price: \$30.00

No. 3099C - 18K Solid Green Gold, Hanlin Design, Long model with clip

Code: ANCAD

List Price: \$30.00

No. 3091C - 18K Solid Green Gold, Hand Engraved, Long model with clip

Code: ABAMT

List Price: \$35.00



3091 W



3097 W



3097 C



3099 C

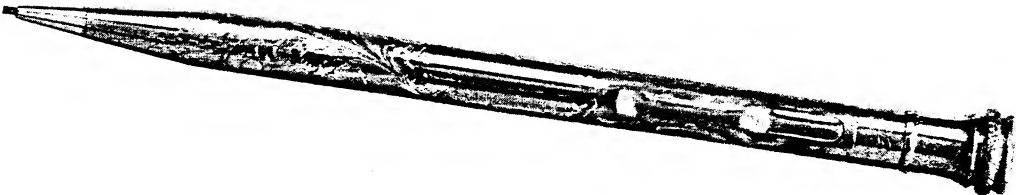

3091 C



WAHL-EVERSHARP

Yellow gold filled pens in exclusive designs created by WAHL-EVERSHARP artists. Ring Colonial attractively decorated with enamel, Colonnade, yellow gold over black enamel, Grecian Border, an exclusive engine turned design.

- No. 5271W - Yellow Gold Filled, Ring Colonial Design. Ladies' model, short with ring - No. 2 nib.  
Code: STSSH *List Price: \$6.00*
- No. 5114W - Yellow Gold Filled, Grecian Border Design. Midget barrel - No. 0 nib  
Code: RACER *List Price: \$5.00*
- No. 5273W - Yellow Gold Filled, Colonnade Design. Ladies' model with ring cap - No. 2 nib  
Code: STONG *List Price: \$6.00*
- No. 7414C - Yellow Gold Filled, Grecian Border Design. Long model with clip, fitted with No. 4 Personal/Point Interchangeable nib  
Code: RTRUP *List Price: \$8.00*
- No. 7473C - Yellow Gold Filled, Colonnade Design. Long model with clip, fitted with No. 4 Personal/Point Interchangeable nib  
Code: STOSK *List Price: \$8.00*
- No. 7471C - Yellow Gold Filled, Ring Colonial Design. Long model with clip, fitted with No. 4 Personal/Point Interchangeable nib  
Code: STEWL *List Price: \$8.00*

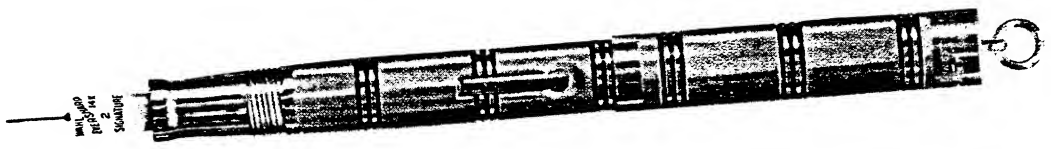

5271 W



5114 W

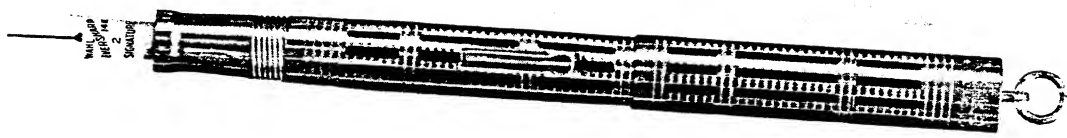

5273 W

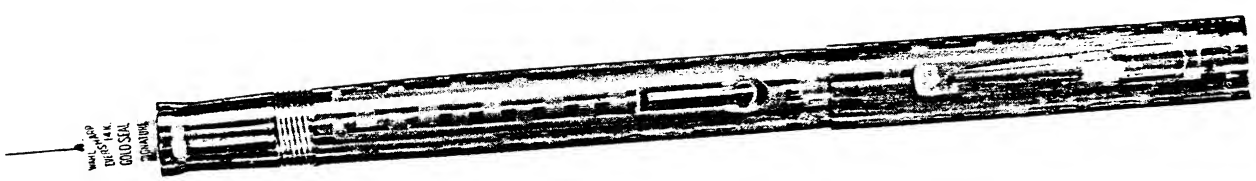

7414 C

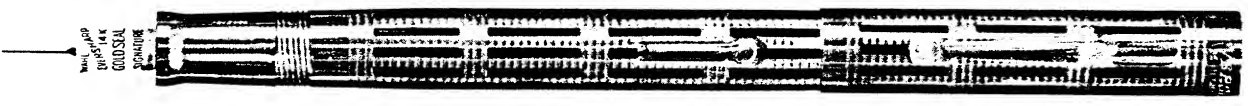

7473 C

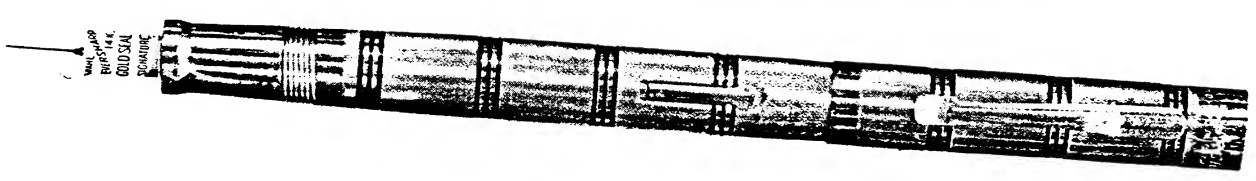

7471 C

**WAHL - EVERSHARP**

Yellow Gold Filled Ever-sharps for both men and women. Pencils of just the right size for purse as well as vest pocket. The exclusive designs have been created by our own artists.

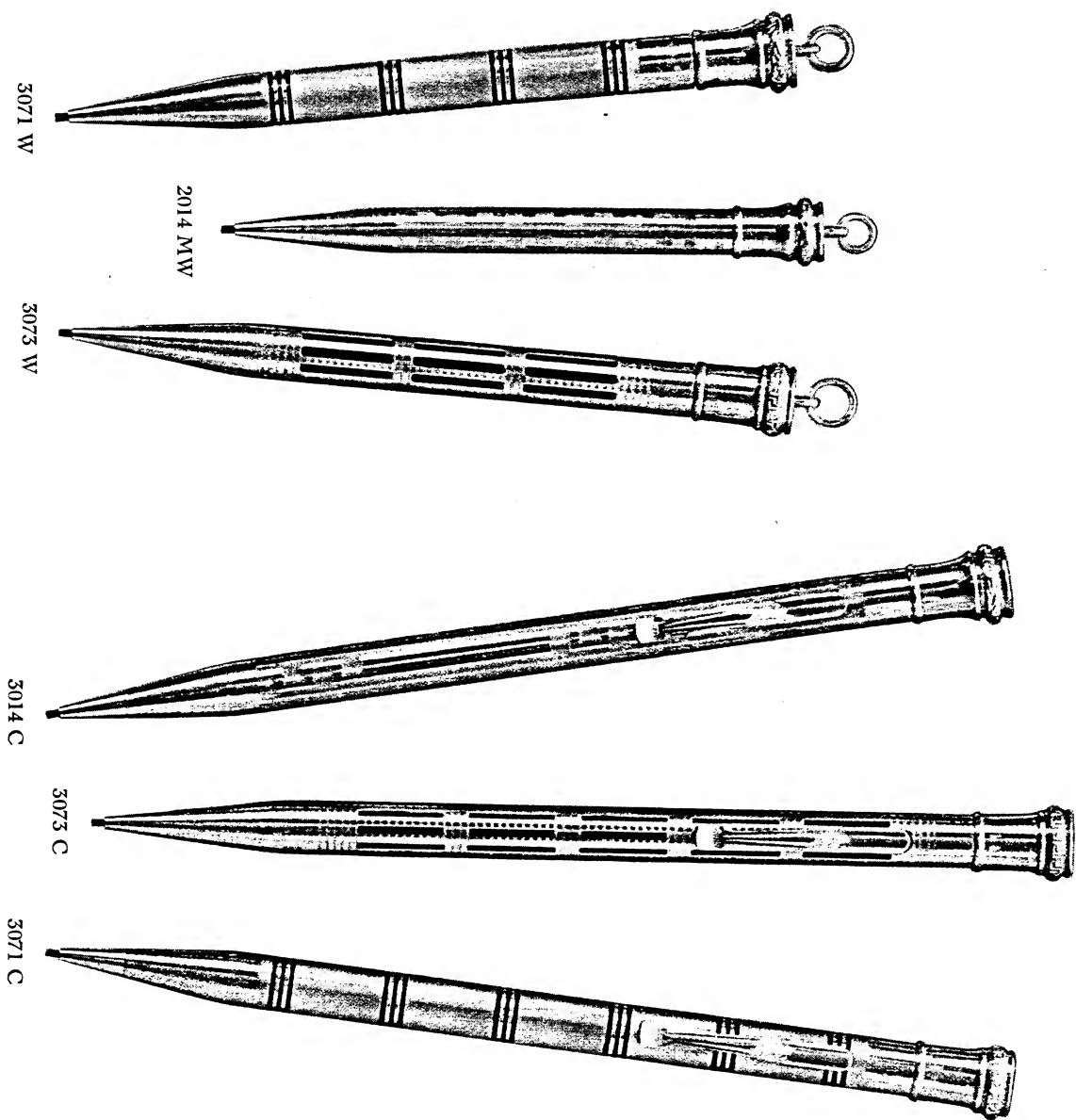

No. 3071W - Yellow Gold Filled, Ring Colonial Design. Ladies' model with ring cap  
*Lid Price: \$5.00*

No. 2014MW - Yellow Gold Filled, Midget, Grecian Border Design. Ladies' model with ring cap  
*Lid Price: \$5.50*

No. 3073W - Yellow Gold Filled, Colonnade Design. Ladies' model with ring cap  
*Lid Price: \$5.00*

No. 3014C - Yellow Gold Filled, Grecian Border design. Long model with clip  
*Lid Price: \$5.00*

No. 3073C - Yellow Gold Filled, Colonnade Design. Long model with clip  
*Lid Price: \$5.00*

No. 3071C - Yellow Gold Filled, Ring Colonial Design. Long model with clip  
*Lid Price: \$5.00*

WAHL - EVERSHPARP

THESE EVERSHPARPS in a variety of styles and designs of filled yellow gold will meet the demands of all people. Both men and women will be delighted with a choice made from this page.

- No. 3060C - Yellow Gold Filler.  
Plain long model with clip.  
*Code:* CACAB *List Price:* \$3.00
- No. 3061C - Yellow Gold Filler.  
Check Design, long model with clip.  
*Code:* CAAYH *List Price:* \$3.50
- No. 3060W - Yellow Gold Filler.  
Plain Ladies' model with ring cap.  
*Code:* CACXC *List Price:* \$3.00
- No. 3060SC - Yellow Gold Filler.  
Plain short model with clip.  
*Code:* CACXD *List Price:* \$3.00
- No. 1060W - Yellow Gold Filler.  
Match pencil. Plain with ring cap.  
*Code:* CAEYJ *List Price:* \$1.00
- No. 3061SC - Yellow Gold Filler.  
Check Design - short model with clip.  
*Code:* CAZMZ *List Price:* \$3.50
- No. 3061W - Yellow Gold Filler.  
Check Design - Ladies' model with ring cap.  
*Code:* CAAYK *List Price:* \$3.50

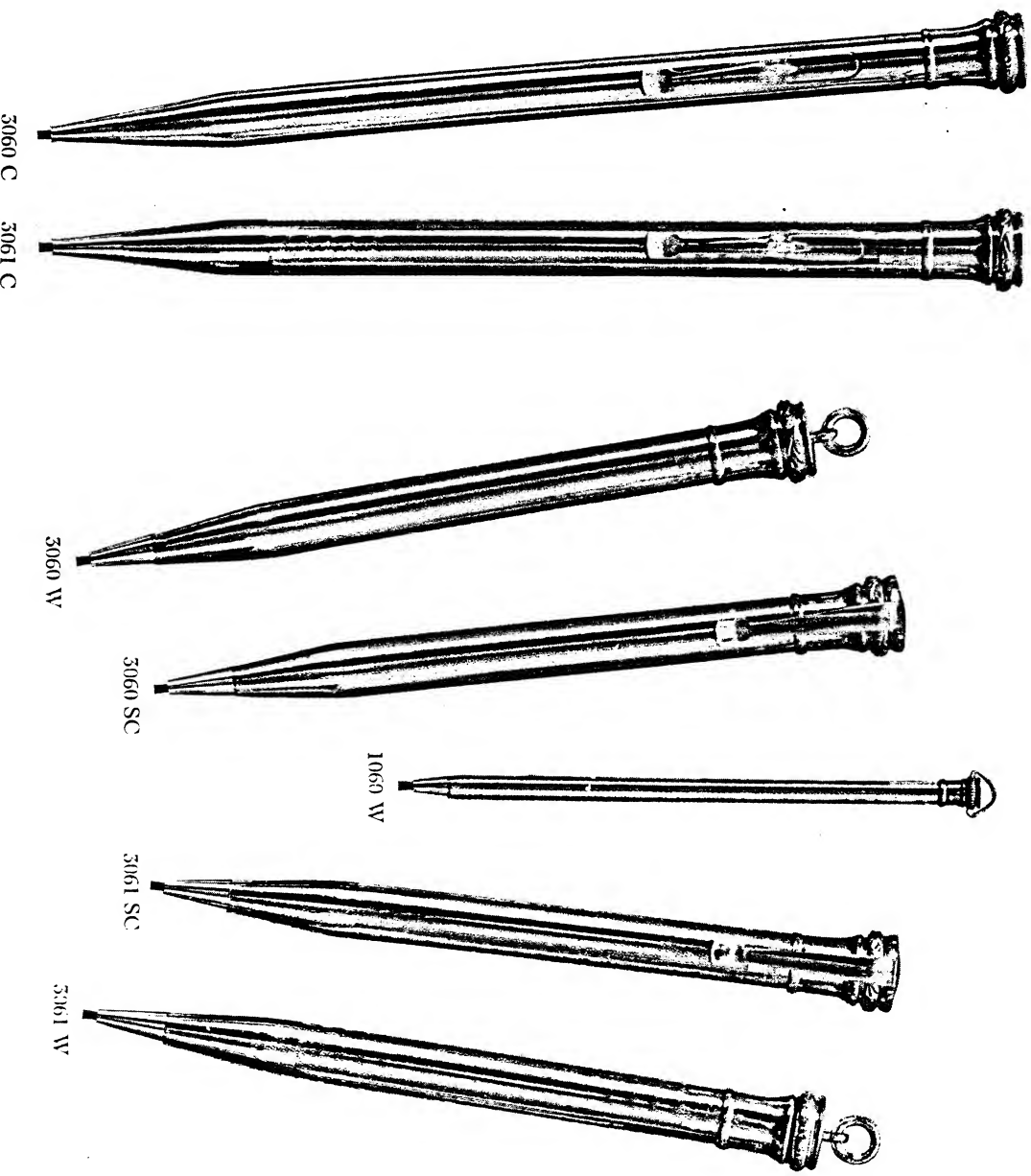

**WAHL - EVERSHARP**  
STERLING SILVER  
AND  
SILVER PLATED  
PENS AND PENCILS

WAHL - EVERSHARP

THESE WAHL-EVERSHARP Sterling Silver pens and pencils equal in quality and appearance the finest gifts in the jewelry art.

- No. 5255W - Sterling Silver. Hand Engraved Ladies' model, short with ring cap - No. 2 nib  
Code: MA4111 Lid Price: \$8.00
- No. 7455C - Sterling Silver. Hand Engraved, long model with clip. No. 4 Personal Point Interchange-able nib  
Code: R100X Lid Price: \$12.50
- No. 3055W - Sterling Silver. Hand Engraved Ladies' model - short, with ring cap  
Code: DA41V Lid Price: \$6.00
- No. 3055C - Sterling Silver. Hand Engraved, long model with clip  
Code: DA4NS Lid Price: \$6.00
- No. 3055SC - Sterling Silver. Hand Engraved, short model with clip  
Code: TR0X Lid Price: \$6.00



5255 W



7455 C



3055 W

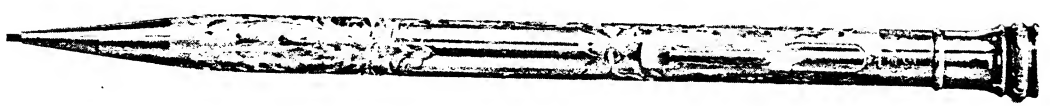

3055 C



3055 SC

**WAHL - EVERSHARP**

In this group of Sterling Silver EVERSHARPS, there is a pencil for every purpose and every class of buyer. Each has the famous EVERSHARP perfect mechanism.

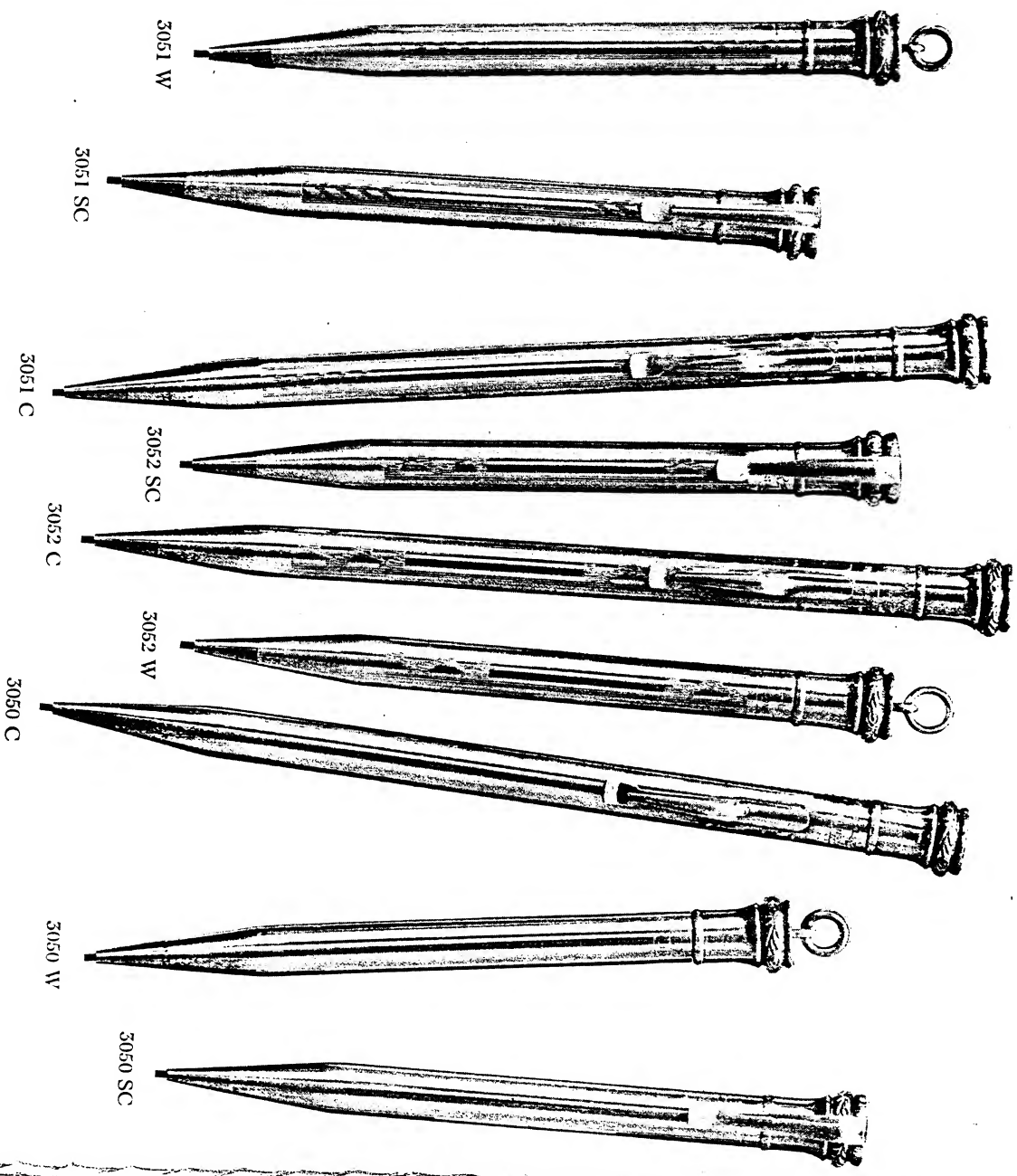

- No. 3051W - Sterling Silver, Chased Design - Ladies' model with ring cap  
Code: DA68G Lid Price: \$3.50
- No. 3051SC - Sterling Silver, Chased Design - Short model with clip  
Code: DA68H Lid Price: \$3.50
- No. 3051C - Sterling Silver, Chased Design - long model with clip  
Code: DA68F Lid Price: \$3.50
- No. 3052C - Sterling Silver, Engine turned - long model with clip  
Code: UR68Y Lid Price: \$3.50
- No. 3052SC - Sterling Silver, Engine turned - short model with clip  
Code: UR68Z Lid Price: \$3.50
- No. 3052W - Sterling Silver, Engine turned - short model with ring  
Code: UR68N Lid Price: \$3.50
- No. 3050C - Sterling Silver, Plain long model with clip  
Code: DA68E Lid Price: \$3.00
- No. 3050W - Sterling Silver, Plain Ladies' model, short with ring  
Code: DA68D Lid Price: \$3.00
- No. 3050SC - Sterling Silver, Plain short model with clip  
Code: DA68C Lid Price: \$3.00

THESE Silver Plated EVERSHARPS, in appearance, resemble to a marked degree the Sterling Silver numbers shown on the preceding pages. The mechanism is the same as in all EVERS HARPS and the plated silver will give almost unlimited service.

- No. 3021C - SILVER PLATED. Engine turned design, long model with clip  
Code: TRIAP *List Price:* \$2.00
- No. 3031C - SILVER PLATED. Chased design, long with clip  
Code: EABPL *List Price:* \$1.50
- No. 3020C - SILVER PLATED. Plain finish, long with clip  
Code: EAGRS *List Price:* \$1.00
- No. 3021W - SILVER PLATED. Engine turned design. Ladies' model with ring clip  
Code: TRIAY *List Price:* \$2.00
- No. 3031W - SILVER PLATED. Chased design, short with ring  
Code: EABPY *List Price:* \$1.50
- No. 3020W - SILVER PLATED. Plain finish, short with ring  
Code: EAGSL *List Price:* \$1.00
- No. 2020MW - SILVER PLATED. Mid-get, with ring  
Code: SNARX *List Price:* \$1.00
- No. 3021SC - SILVER PLATED. Engine turned, short model with clip  
Code: TRIANS *List Price:* \$2.00
- No. 3031SC - SILVER PLATED. Chased design, short with clip  
Code: EABSC *List Price:* \$1.50
- No. 3020SC - SILVER PLATED. Plain finish, short with clip  
Code: EAGZY *List Price:* \$1.00

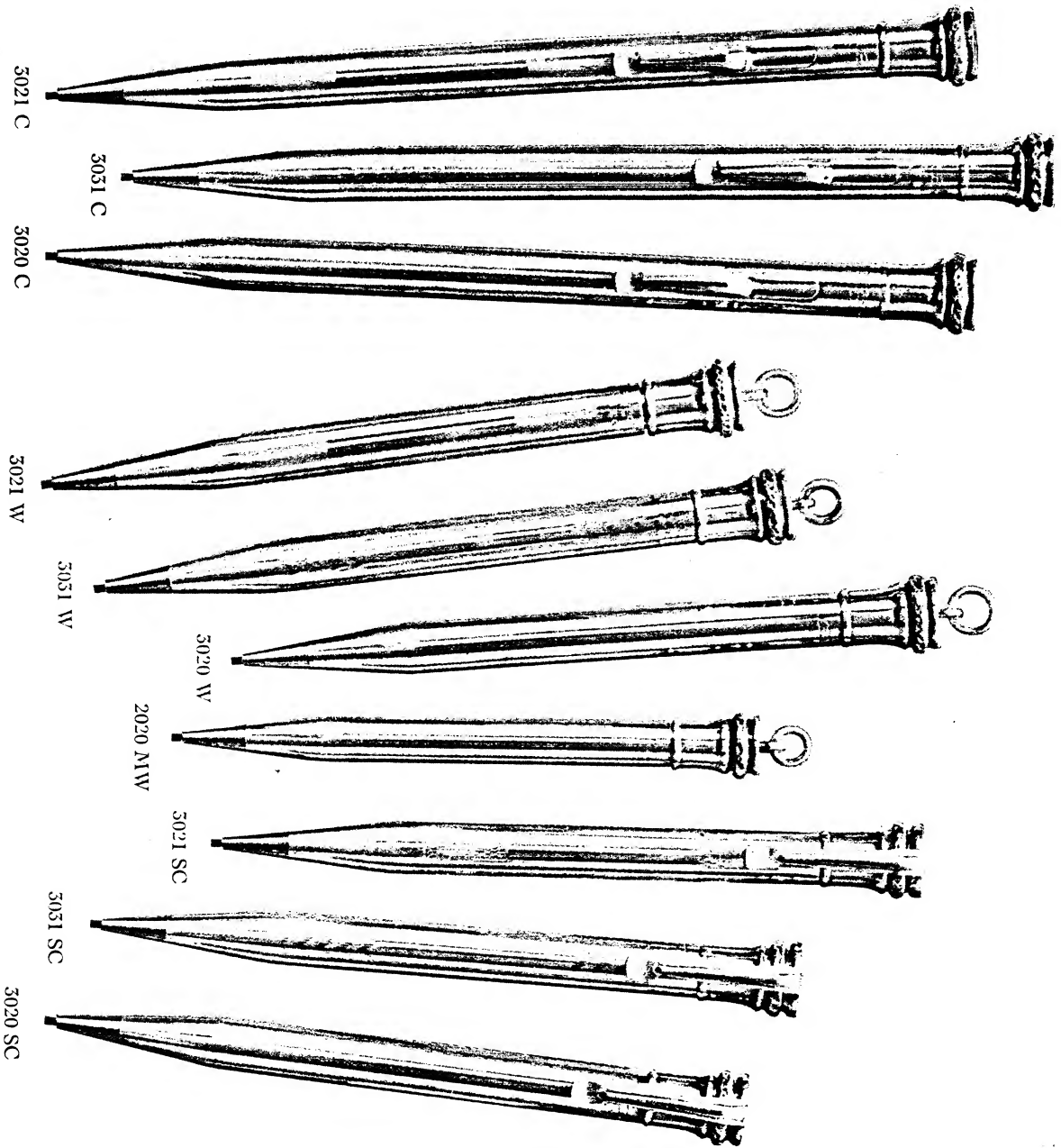

***WAHL - EVERSHARP***

**PENCILS**

ENAMEL—BAKELITE—RUBBER—

PYRALIN—CHECKING—

“SEVENTY-FIVE”

LINES



WAHL - EVERSHARP

These Enamel and Bakelite EVERSHARPS are ideal for everyday use.

- No. 3045C - Red ENAMEL. Octagon barrel, long with clip  
*Lid Price: 50c*  
*Code: RYZS*
- No. 3044C - Red ENAMEL. Round barrel, long with clip  
*Lid Price: 50c*  
*Code: EAKRC*
- No. 3041C - Blue ENAMEL. Round barrel, long with clip  
*Lid Price: 50c*  
*Code: EAKDE*
- No. 3040C - Black. Round barrel, long with clip  
*Lid Price: 50c*  
*Code: EAKVA*
- No. 3046C - Blue. Octagon barrel, long with clip  
*Lid Price: 50c*  
*Code: UMERT*
- No. 3044W - Red ENAMEL. Round barrel, short  
*Lid Price: 50c*  
*Code: EAKOH*
- No. 3041W - Blue. Round barrel, short with ring  
*Lid Price: 50c*  
*Code: UMARB*
- No. 3040W - Black. Round barrel, short with ring  
*Lid Price: 50c*  
*Code: UMAKV*
- No. 3068C - Red. Octagon barrel, long with clip  
*Lid Price: 50c*  
*Code: EALSK*
- No. 3069C - MOTTLED. Octagon barrel, long with clip  
*Lid Price: 50c*  
*Code: EALSM*

These pencils sold singly or in assortments of one dozen on an attractive display card.

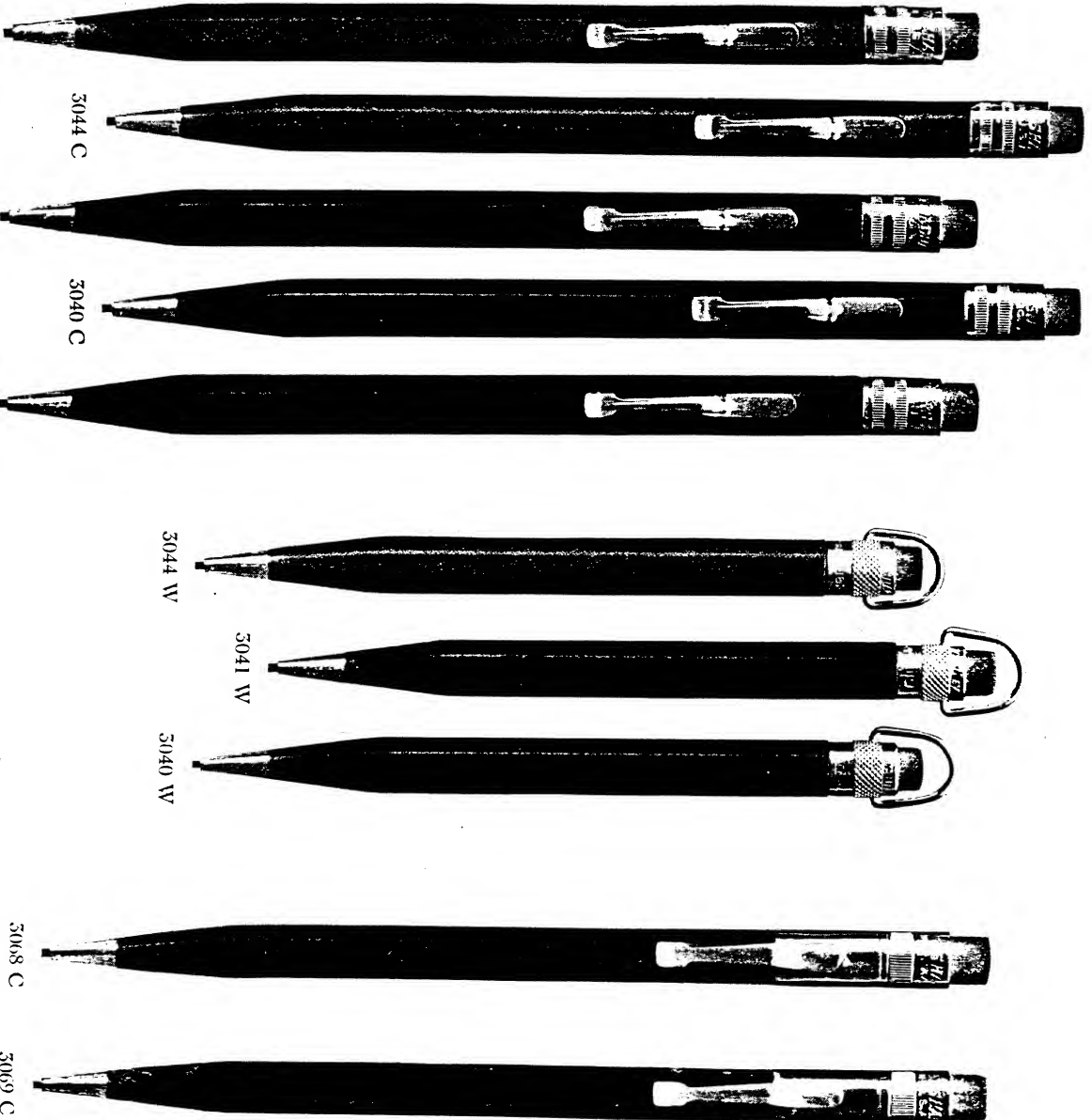

EVERSHARPS in Rubber and Enamel barrels—built for long and satisfactory service.

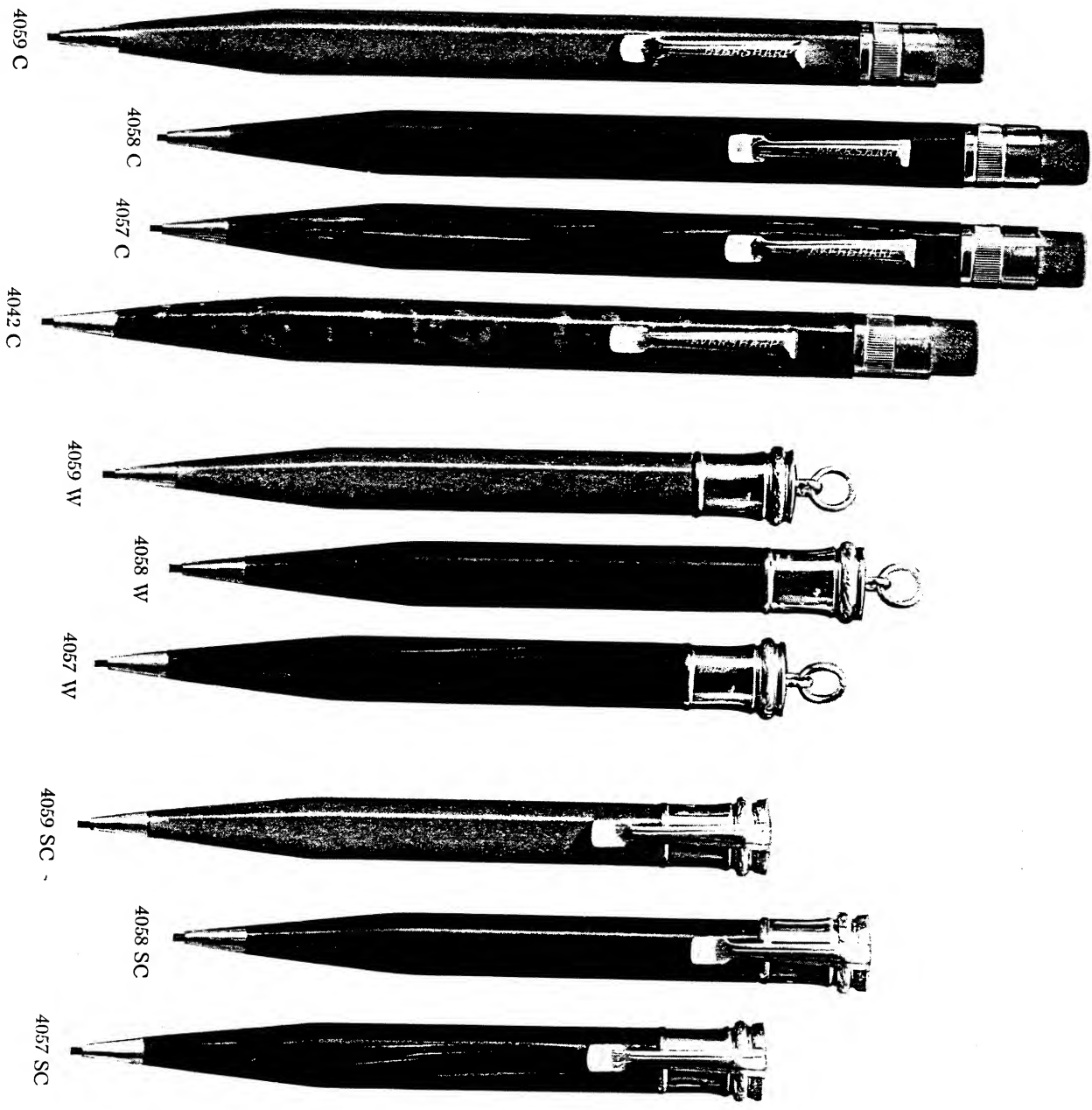

4059 C

4058 C

4057 C

4042 C

4059 W

4058 W

4057 W

4059 SC

4058 SC

4057 SC

No. 4059C - Red Rubber. Long with clip.

Code: RHEXXR Lid Price: 60c

No. 4058C - Black Rubber. Long with clip.

Code: RHEVN Lid Price: 60c

No. 4057C - Rosewood. Long with clip.

Code: THONE Lid Price: 60c

No. 4042C - Green Enamel. Long with clip.

Code: THODY Lid Price: 60c

No. 4059W - Red Rubber. Short with ring.

Code: THENZ Lid Price: 60c

No. 4058W - Black. Short with ring.

Code: THELD Lid Price: 60c

No. 4057W - Rosewood. Short with ring.

Code: THENW Lid Price: 60c

No. 4059SC - Red Rubber. Short with clip.

Code: SOEZO Lid Price: 60c

No. 4058SC - Black. Short with clip.

Code: SOYR Lid Price: 60c

No. 4057SC - Rosewood. Short with clip.

Code: SOYRK Lid Price: 60c

These pencils sold in dozen assortments on attractive display card.

**WAHL - EVERSHARP**

For the first time, WAHL-  
EVERSHARP offers a Pyralin pen-  
cil with unbreakable barrel for  
\$1.00. All models are long, with  
nickel clip, extra leads, and  
concealed eraser. Five colors—  
Black, Blue, Green, Coral and  
Yellow. Barrels are Decagonal  
(10-sided).

- |              |                    |
|--------------|--------------------|
| No. 4080C    | Black              |
| Code: uduvni | List Price: \$1.00 |
| No. 4081C    | Blue               |
| Code: uduvuz | List Price: \$1.00 |
| No. 4082C    | Green              |
| Code: uduvxy | List Price: \$1.00 |
| No. 4083C    | Coral              |
| Code: uduvmb | List Price: \$1.00 |
| No. 4084C    | Yellow             |
| Code: ukredh | List Price: \$1.00 |



4080 C



4081 C



4082 C



4083 C

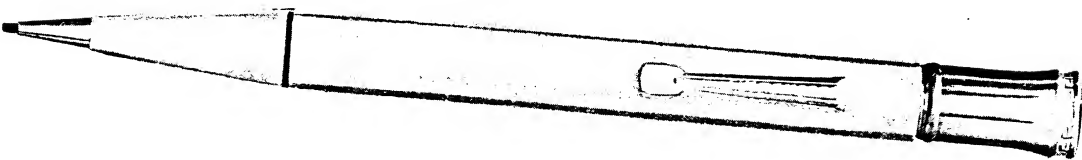

4084 C

WAHL - EVERSHARP

EVERSHARPS in Yellow Gold and Colored Enamel, made especially for checking purposes. They are much in demand by executives, accountants, shipping clerks and stock keepers. These pencils use regular over-size checking leads. Long models with clips.

No. 30260C - Yellow Gold Filled  
Code: SAUNT *List Price: \$3.00*

No. 30240C - Black Enamel  
Code: UMADN *List Price: \$1.00*

No. 30244C - Red Enamel  
Code: FAHBR *List Price: \$1.00*

No. 30241C - Blue Enamel  
Code: UMAPP *List Price: \$1.00*

No. 30243C - Yellow Enamel  
Code: UMACG *List Price: \$1.00*

No. 30242C - Green Enamel  
Code: UMAVF *List Price: \$1.00*

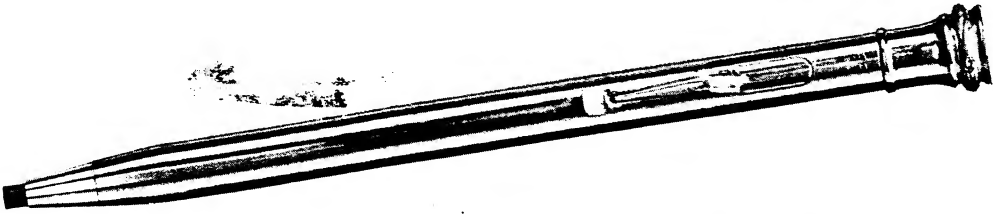

30260 C



30240 C



30244 C



30241 C

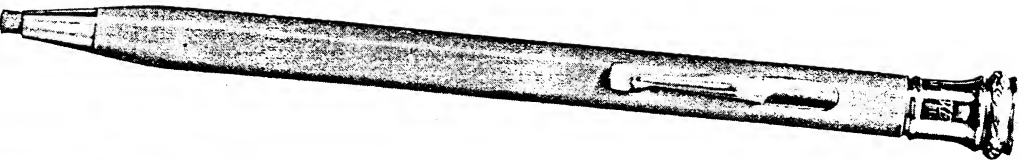

30243 C

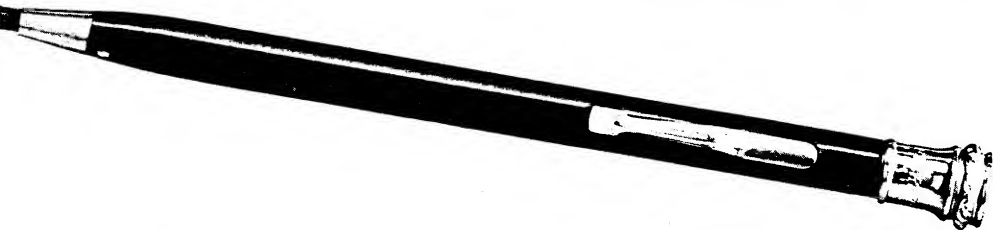

30242 C

**WAHL-EVERSHARP**

THE WAHL-EVERSHARP "Seventy-Five" Line of all purpose pencils in Gold, Silver, and Rubber. The lead is .075 in diameter for checking purposes. It is strong and will not break under heavy pressure. These pencils are ideal for manifolding or where heavy writing is desired.

- No. 30720C - Silver Plated. Long with clip  
Code: RH10      *Lid Price:* \$1.00
- No. 30714C - Yellow Gold Filler. Long with clip  
Code: SOVR      *Lid Price:* \$5.00
- No. 39709C - Red Rubber. Long with clip  
Code: SNAYR      *Lid Price:* \$5.00
- No. 39707C - Rosewood Rubber. Long with clip  
Code: SKARP      *Lid Price:* \$5.00
- No. 40759C - Red Rubber. Long with clip  
Code: RIUCY      *Lid Price:* \$1.00
- No. 40758C - Black Rubber. Long with clip  
Code: RHISM      *Lid Price:* \$1.00
- No. 40757C - Rosewood Rubber. Long with clip  
Code: SOALN      *Lid Price:* \$1.00



30720 C



30714 C



39709 C



39707 C



40759 C



40758 C



40757 C

# The Wahl Well

## The New and Improved Way to Fill Fountain Pens



**T**HE WAHL Well is the first satisfactory device ever offered for filling modern fountain pens without soiling the hands. It is the result of many months of work to develop a convenient fountain-pen filling device which would be easy to operate, preserve the quality of the ink, avoid sedimentation and evaporation, withdraw all the ink without tipping, and prevent pen point from coming in contact with the hard glass surface. It entirely eliminates the messiness which has always accompanied the filling of a fountain pen.

The WAHL Well holds six ounces of the best quality permanent Royal Blue fountain pen ink that it is possible to manufacture. It is simple to operate, and makes the filling of pens easier and more pleasant. The pen barrel is not immersed in the ink. Filling a pen from the old ink bottle was invariably a messy operation, and no one ever had a rag handy to dry the pen and fingers after performing the task.

One will find real satisfaction in filling a pen the WAHL Well way.

### Advantages

1. Keeps pen and fingers clean—the ink is drawn up into the inside of the pen—no ink is deposited on outside of barrel. The simplicity and ease in operating the WAHL Well to fill fountain pens and device.

2. Prevents pen point—prevents point of pen touching hard glass bottom of bottle. This is a boon to the fountain pen and the satisfactory service required of it in use. Frequently the pen point is bent or forced out of proper position by stubbing it on the glass bottom in filling in the ordinary open-mouth ink bottle. This cannot occur in the WAHL Well.
3. Prevents waste—all ink can be withdrawn without tipping bottle. The patented stopper, with the rubber tube reaching down to the very bottom of the well, forms a hermetic seal, so that even though the cap is left off the bottle, the ink will not spill when the bottle is tipped over.
4. Keeps ink clean and in good condition—stopper prevents dust and dirt getting into ink. No matter how long the bottle is in the desk, due to the patented stopper, the ink is always clean. Evaporation cannot take place in the WAHL Well and there is never any thick or dirty ink to fill up and clog the feed channels of your pen. With no thick and gummy ink to choke your pen, it is necessary to wash the pen with water much less frequently—and good, clean ink insures greater length of life for the rubber ink sac of your pen.

Every person who has a desk set or an ordinary fountain pen should have a WAHL Well in his desk drawer, as it is the easiest and most convenient way to fill a fountain pen. Experience has shown that once a person has used the WAHL Well and become accustomed to its many conveniences, he will never go back to the ordinary ink bottle. This unusual and attractively shaped bottle is further identified by a red cap.

No.	LIST PRICE	TEL. WORD
NK1	\$0.50 Each	SKINP
	\$6.00 Dozen	
NK2	\$0.50 Each	TROSB
	\$6.00 Dozen	

1 WAHL Well containing 6 oz. Blue-Black Ink  
1 WAHL Well containing 6 oz. Royal Blue Ink

Minimum order is One Dozen Bottles.

Each bottle is packed in a neat blue cardboard box with a red top. Twelve WAHL Wells are packed in a case.

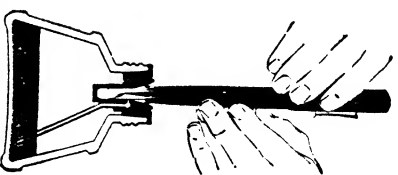

### How the WAHL WELL Operates

With filling lever open, push the pen down into the rubber stopper snugly until the lower part of the barrel makes an air-tight fit, as demonstrated in illustration.

When the filling lever is released, the suction of the ink sac immediately draws the ink up through the rubber tube that extends to the lowest part of the bottle into the reservoir into which the pen point has been placed, and the ink is sucked on up into the barrel of the pen. After holding the pen in the stopper for ten seconds to allow it to draw a full charge of ink, it is removed and is ready to write instantly. There is no ink on the lower barrel section which must be wiped off, as it has not been in the ink.

## Eversharp Utility Unit

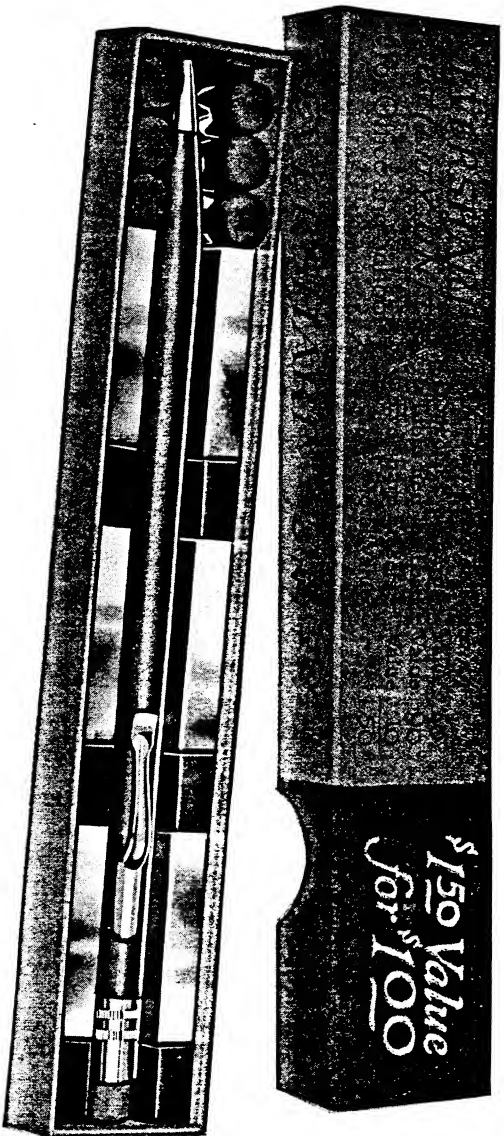

**T**HE EVERSHARP UTILITY UNIT is an attractive package originated and designed to provide a greater number of people with EVERSHARP pencils for use in offices, schools and homes. The Unit is made up of—

- 1 special enameled EVERSHARP, value.....\$0.50
- 6 tubes Red Top EVERSHARP Lead (18 sticks in tube; total, 108 sticks), value..... .90
- 6 EVERSHARP Erasers, value..... .10
- 1 Instruction sheet.....

Total value..... \$1.50  
List price for complete unit..... \$1.00

The list price of \$1.00 for this package gives an unusual purchase, as the six tubes of Red Top Lead and six erasers alone are worth the price of the Unit, making the genuine 50c EVERSHARP included free.

This self-contained unit is enclosed in the neat and inviting package illustrated above in actual size. Just large enough to hold the pencil, leads and erasers. A permanent, strong box, which can be used to store the extra leads and erasers as long as they last.

This offer of free EVERSHARP pencils has a fine appeal to every office—large and small. Many offices are now furnishing refill leads to their employees. Here is a fine way to secure the pencil as well and do away with the annoyance and high cost of wooden pencils.

Most suitable is this Utility Unit for the student. It is a perfect piece of equipment for his requirements. Every student, whether in grade school, high school or college, can easily pay for a Utility Unit out of the savings in

wooden pencils in a very short time. With one of these Units he will have a genuine EVERSHARP, with years of service ahead of it, plus a year's supply of refill leads.

You can buy Red Top Leads in the Utility Unit in any one of the seven standard degrees of hardness. Only one grade of lead is packed in each individual unit, but cartons of a dozen units may be assorted if you prefer. (B or HB is the usual choice for general work, and HB will be shipped on orders not clearly specifying grade.) The EVERSHARPS are also provided with clip or without clip, as preferred.

Symbol Asst. No.	4H151	4H Lead	Pencil without clip
Symbol Asst. No.	2H151	2H Lead	Pencil without clip
Symbol Asst. No.	H151	H Lead	Pencil without clip
Symbol Asst. No.	HB151	HB Lead	Pencil without clip
Symbol Asst. No.	F151	F Lead	Pencil without clip
Symbol Asst. No.	B151	B Lead	Pencil without clip
Symbol Asst. No.	2B151	2B Lead	Pencil without clip
Symbol Asst. No.	4H151C	4H Lead	Pencil with clip
Symbol Asst. No.	2H151C	2H Lead	Pencil with clip
Symbol Asst. No.	H151C	H Lead	Pencil with clip
Symbol Asst. No.	HB151C	HB Lead	Pencil with clip
Symbol Asst. No.	F151C	F Lead	Pencil with clip
Symbol Asst. No.	B151C	B Lead	Pencil with clip
Symbol Asst. No.	2B151C	2B Lead	Pencil with clip

Each Unit is packed in individual box—12 boxes to counter display carton. List Price \$12.00 per dozen units. Minimum order, 12 boxes. (Assorted grades if desired.)

## Red Top Eversharp Thin Leads

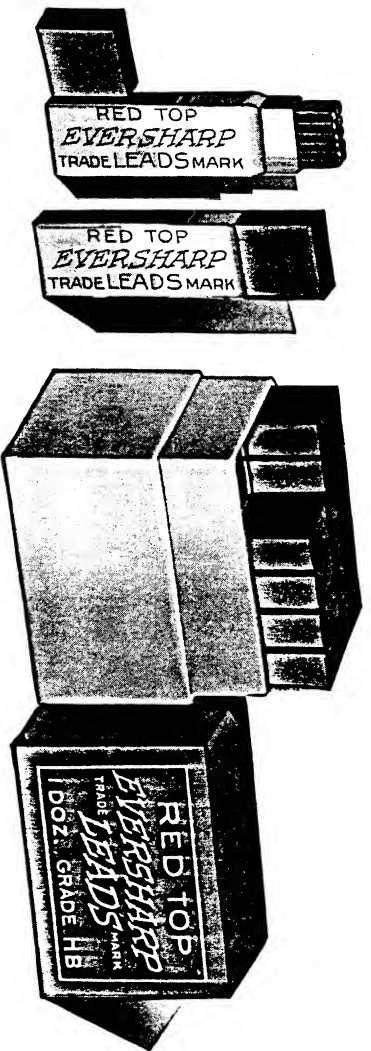

ED Top Eversharp Leads are made of the finest grades of domestic and imported graphites, clays and waxes. They are made in our own complete plant—strong, smooth-writing and uniform year after year both as to grade and color.

The diameter of Red Top Eversharp Leads is accurately maintained to fit the patented rifled tips of Eversharp pencils. For perfect writing satisfaction, only Eversharp Leads should be used.

Made in the following grades and colors (standard Eversharp thin diameter):

**2B**—Extra Soft      **B**—Soft      **HB**—Medium Soft      **F**—Firm  
**H**—Medium Hard      **2H**—Hard      **4H**—Very Hard  
**Colors—(Seven Grades)**  
**Black—(Seven Grades)**  
**Red**      **Blue**      **Green**      **Yellow**      **Purple Copying (Indelible)**

Eversharp leads are packed in Red Top containers as follows: 18 sticks of black lead, any grade, in metal tube. 12 sticks of colored lead in metal tube of same color.

*List Price:* 15 cents per tube. Minimum order, 12 tubes of one grade or color.

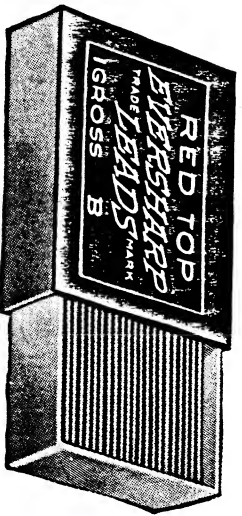

144 sticks of lead of one grade or color in sliding cardboard box, for office use (*illustrated at left*).

*List Price:* Black Lead, 75c per box. Red, Blue, Green, Yellow and Purple Copying (Indelible), \$1.50 per box. Minimum order—one box.

## Eversharp Erasers



Every Eversharp eraser can be easily replaced, when worn out, with a new one. They are made of firm, smooth, red rubber and have excellent erasing qualities. Above are shown the four sizes and styles of Eversharp erasers, and a brief explanation to indicate with which Eversharp pencils they are used. When ordering extra erasers, be sure to specify the styles wanted.

**REG**—Mounted eraser for use with all regular diameter precious-metal, rubber-barrel Eversharp pencils with a double magazine and the new Oversize models with straight caps.

**BM**—Mounted eraser for use with bakelite-barrel Eversharp pencils having the eraser shell open at both ends. Also used with the enamel-barrel pencils.

**SJ**—Short, mounted Jumbo eraser for use with \$3.00 and \$3.50 Oversize Eversharp pencils having a metal cap to conceal eraser.

**LJ**—Long, mounted Jumbo eraser for use with \$0.60 and \$1.00 Oversize Eversharp pencils.



## Red Top Eversharp Thick Writing Leads

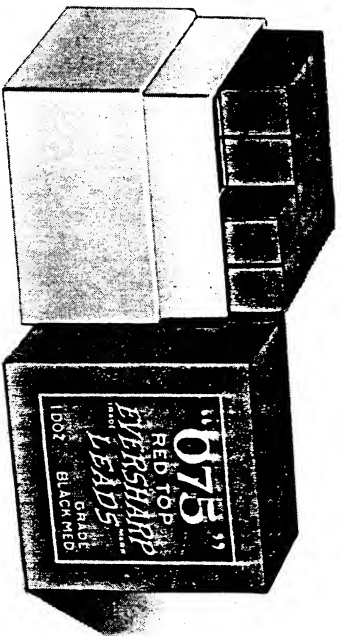
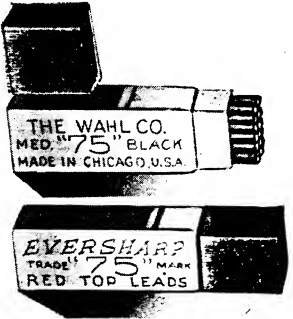

**A** New departure in lead making is marked by the addition of these medium-thick writing leads for use in Eversharp pencils. They are made especially for those who like to write with a heavy line, and who prefer a lead that can be used for checking and manifold-ing, as well as for continuous writing purposes. They are .075 of an inch in diameter, as compared with the .046 of an inch in diameter of the standard thin leads.

Only the finest materials are used in the manufacture of these leads. They are carefully calibrated to a constant diameter, and are of the same high quality in strength, smoothness and uniformity of grade and color as the regular line of thin diameter Eversharp leads.

**BLACK**  
(*Graphite*)  
Medium  
Soft

**COLORS**  
(*Medium Grade Only*)  
Red  
Blue  
Green  
Yellow  
Purple Copying (Indelible)

Packed eight sticks of one grade or color in Red Top metal tube. For easy identification, tubes correspond in color with the leads.

*List Price:* 15 cents per tube. Minimum order—twelve tubes of one grade or color, packed in carton.

## Eversharp Checking Leads

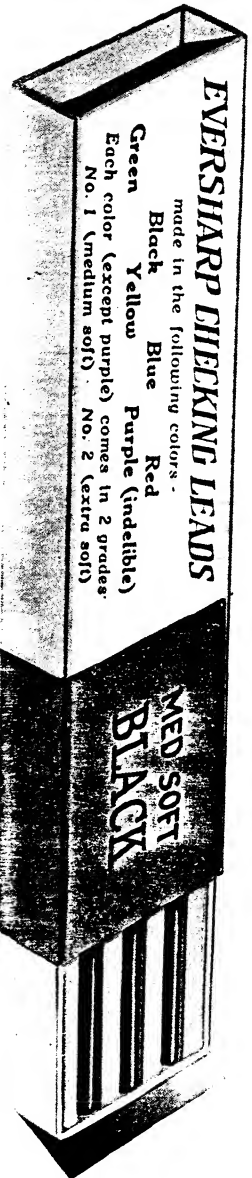

**EVERSHARP CHECKING LEADS**  
made in the following colors -  
Green Black Yellow Blue Purple (Indelible)  
Each color (except purple) comes in 2 grades -  
No. 1 (medium soft) No. 2 (extra soft)

EVERSHARP *Checking Leads* are made for use in the Eversharp Checking and "Executive" pencils. These leads are .120 of an inch in diameter, and are especially adapted to heavy checking work, or marking rough surfaces. Eversharp *Checking Leads* are furnished in two grades: No. 1 (medium soft), and No. 2 (extra soft). The No. 2 grade writes well on glass, china, and other smooth surfaces. Both grades are made in the following colors:

Red  
Blue  
Green  
Yellow  
Black

Purple Copying (Indelible) *Checking Leads*, which write black and copy purple, can be furnished in the No. 1 grade (medium soft) only.

EVERSHARP *Checking Leads* are packed six of one grade or color in cardboard box, as shown above.

One box of checking leads included free with each Checking or "Executive" pencil. Black checking leads are always furnished unless otherwise ordered.  
*List Price:* 15 cents. Minimum order—6 boxes of assorted grades and colors.

## Eversharp Lead Counter Display Assortment

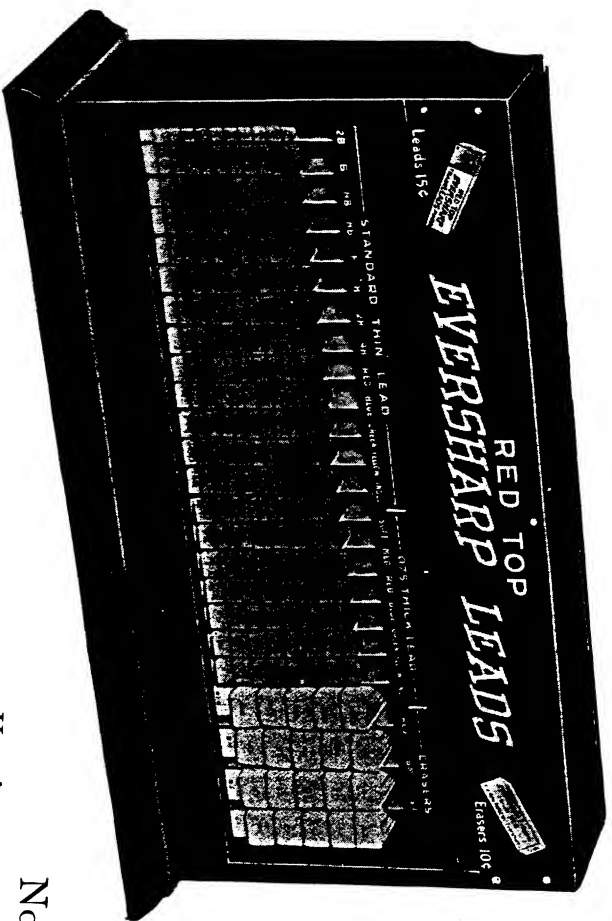

**I**NCREASED sales of Eversharp Leads follow wherever they are displayed in these handsome counter display stands. The stands are a constant reminder to your customers, and serve as an invitation to them to reload their Evershars. Every store can profit by the use of one or more of these busy silent salesmen placed in prominent locations.

Eversharp Lead counter display stands are very substantially built, beautifully colored, and will remain attractive for years. They can be refilled easily when the assortment of leads needs replenishing. Lead tubes are projected for removal by patented trigger release.

These lead stands are made in two sizes, and are furnished only with standard assortments of Eversharp Leads as listed on this page.

### No. 12 Lead Stand Assortment

Here is a practical assortment for the dealer who wishes a small stand with a complete assortment of Red Top Leads. This stand has the same trigger release as the one shown above and requires only half the

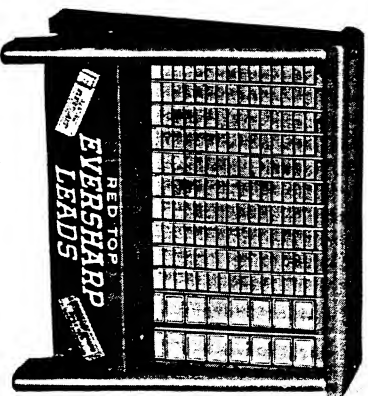

space on the counter. Assortment contains:

24 tubes HB, 12 tubes each 2B, B, F and H, 6 tubes each Red, Blue and Indelible .046 diameter; 3 tubes each Soft Black and Medium Black, 2 tubes each Red, Blue and Indelible .075 diameter; 3 Boxes each Regular, BM, LJ and SJ Erasers.

*List Price* \$16.50

*No. 12 Lead Stand shown at left furnished free with each assortment.*

### Red Top Eversharp Lead Assortment No. 100

Large size assortment. Contents: 12 tubes each, grades 2B, B, HB, F, H, 2H, 4H, Red, Blue, Green, Yellow and Purple .046 diameter Lead; and 9 tubes each, grades Black Soft, Black Medium, Red, Blue, Green, Yellow and Purple .075 diameter Lead. Also 4 boxes each Regular, LJ, BM, and SJ Erasers.

Display Stand shown above furnished FREE with this assortment. *List Price:* \$32.65.

# Wahl-Eversharp Gold Seal Nibs



WAHL-EVERSHARP No. 2 nibs are ideal for those who prefer a small pen and they are particularly well adapted for the feminine hand. These nibs are made with the same care and precision as all WAHL-EVERSHARP nibs and the very generous application of iridium on the point makes these nibs second to none for durability and service. These flexible nibs are slightly longer than other nibs,

they yield slightly under the slightest pressure and shade easily when desired. Flexible nibs are excellent for general use and for those who prefer a cushion effect for shading the letters. The fine, medium and broad models give the user a choice as to width of tip and consequent thickness of line. The No. 0 nib is made with medium tip only.

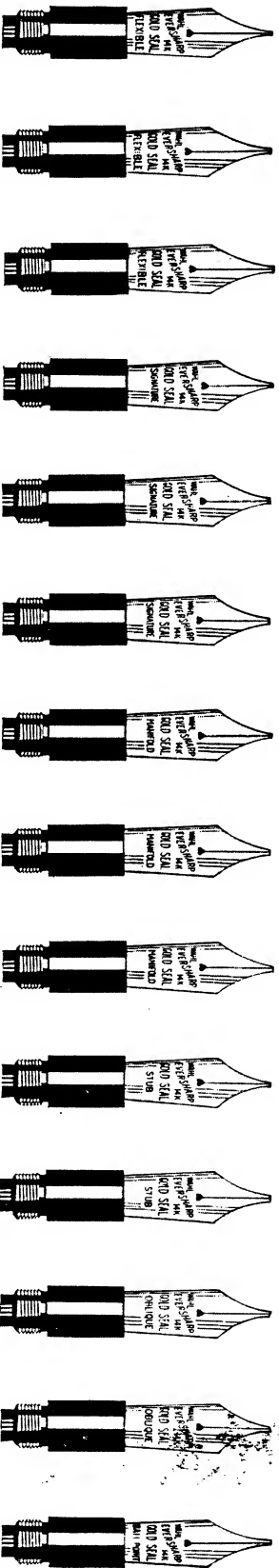

Above we have illustrated the fourteen *Gold Seal* nibs, No. 4 size. The style and writing qualities of these nibs are identical with the No. 6 nibs shown below—the only difference being in the size. All WAHL-EVERSHARP nibs are stamped from 14K gold and ground by expert nib grinders. These skilled craftsmen, under the direction of critical inspectors, produce in THE WAHL COMPANY plant, the entire nib. No part of the manufacture is left to outsiders or those not thoroughly familiar with general writing habits. Manifold nibs are very stiff. Considerable pressure can be applied to them without affecting

the line in writing. The Signature (semi-flexible) nib is a WAHL-EVERSHARP creation. Signature nibs respond slightly to pressure and are ideal for all general purposes. Flexible nibs are excellent for shading or for those who apply practically no pressure to the paper. Among the WAHL-EVERSHARP *Gold Seal* nibs is one to exactly fit the hand of each individual. Retail salespeople should study the customer's hand when showing a pen and thus select almost instantly the proper point for that particular individual.

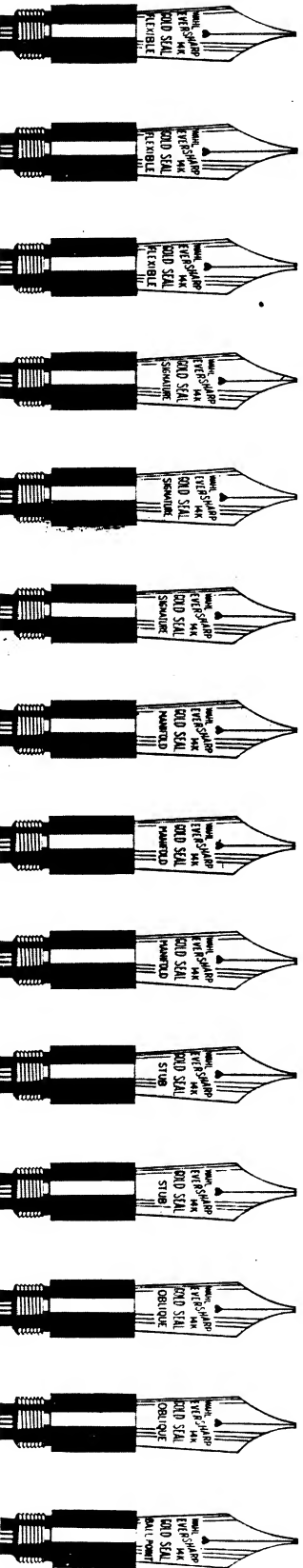

WAHL-EVERSHARP *Gold Seal* nibs are made in two sizes, No. 4 and No. 6. The No. 6 nibs shown above are furnished in three degrees of flexibility—Manifold, Signature and Flexible. Each of these three is furnished in a complete range of fineness from a very fine to the broad stub. The above illustration shows a choice of fourteen popular nibs from which can be selected a point for any style of writing. These nibs are stamped "WAHL-EVERSHARP *Gold Seal*" which is the identifying mark of a perfect nib. Manifold nibs are very stiff. Consid-

erable pressure can be applied to them without affecting the line in writing. The Signature (semi-flexible) nib is a WAHL-EVERSHARP creation. Signature nibs respond slightly to pressure and are ideal for all general purposes. Flexible nibs are excellent for shading or for those who apply practically no pressure to the paper. Each nib is made from pure gold alloyed to 14k and tipped with the highest grade osmiridium—the hardest known metal, to insure long and satisfactory service.

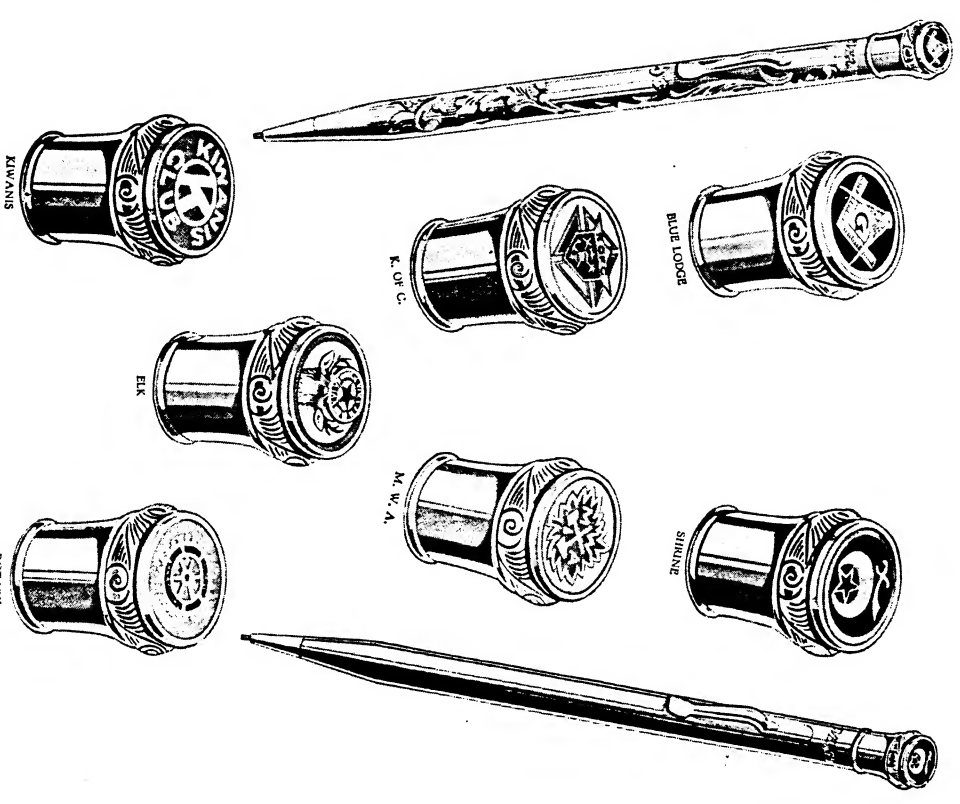

## Eversharp Enamelled Emblem Caps

The emblems shown above are beautifully enamelled in full colors on the top of EVERSARP pencil caps. Orders for silver-plated, sterling silver, and gold-filled EVERSARPS bearing caps with the emblem of any of the following organizations can be furnished from stock:

Blue Lodge            K. of C.            Elk  
 Shrine                    M. W. A.          Kiwanis  
    Rotary

Complete information regarding special emblem caps for other organizations, schools, or with trade-marks, furnished upon request.

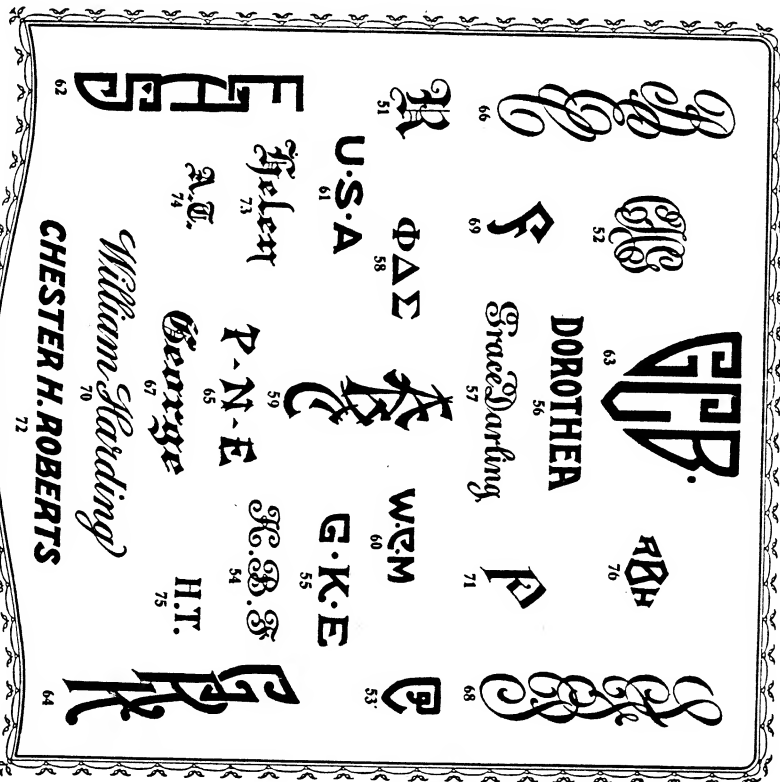

## Styles of Hand Engraving

Any of the above styles, with the exception of No. 65, can be engraved on all WARRI-EVERSARP Pens and Pencils. Style No. 65 can be engraved only on pencils and pens with plain barrels. Single initials and condensed monogram styles can be engraved on the tops of pen and pencil caps.

No.	Description	Price per Letter
51	Old English.....	10c
52	Ribbon Monogram.....	30c
53	Fancy Block.....	30c
54	Vertical Script.....	20c
55	Fancy Block.....	20c
56	Plain Block.....	4c
57	Vertical Script.....	4c
58	Greek Letters.....	3c
59	Drop Lap Monogram.....	10c
60	Modern Block.....	30c
61	Plain Block.....	4c
62	Drop Block Monogram.....	4c
63	Block Monogram.....	30c
	Per 3 Letters.....	50c
No.	Description	Price per Letter
64	Drop Block Monogram.....	30c
65	Lap Letters.....	10c
66	Drop Ribbon Monogram.....	30c
67	Slanting Old English.....	30c
68	Drop Ribbon Monogram.....	6c
69	Old Block.....	30c
70	Plain Script.....	10c
71	Old Block.....	5c
72	Slanting Block.....	10c
73	Old English.....	4c
74	Old English.....	6c
75	Roman.....	10c
76	Diamond Monogram.....	75c

## Wahl-Eversharp Pen Parts Price List

	Nib No.	Nib Price	Allowance on Old Nib	Feed Bar	Point Section	Sub-Section	Barrel with Lever and Pressure Bar	Cap with Ring or Clip	Ink Sac	Lever	Pressure Bar	Clip	Ring	Barrel Complete with Section and Sac (no Nib or Feed Bar)	Complete Cap with Gold Filled Bands, Clip or Ring	Cap without Clip or Ring	Complete Pen without Horn	Complete Pen with Horn and Swivel
<b>METAL</b>																		
Silver Filled.....	2	1.25	.20	.60	.75	.25	1.25	1.25	.25	.30	.50	.50						
Silver Filled.....	4	2.00	.40	.60	.75	.25	2.00	2.00	.25	.30	.30	.50						
Sterling Silver and Yellow Gold Filled (Chased).....	2	1.25	.20	.60	.75	.25	2.00	2.50	.25	.35	.50	.75						
Sterling Silver and Yellow Gold Filled (Chased).....	4	2.00	.40	.60	.75	.25	3.00	3.50	.25	.35	.50	.75						
Green Gold Filled (Chased).....	2	1.25	.20	.60	.75	.25	2.75	3.25	.25	.40	.30	.85						
Green Gold Filled (Chased).....	4	2.00	.40	.60	.75	.25	3.75	4.25	.25	.40	.30	.85						
Sterling Silver or Yellow Gold Filled (Engine Turned).....	0	1.00	.10	.50	1.00	.25	2.25	2.75	.25	.35	.25							
Sterling Silver or Yellow Gold Filled (Engine Turned).....	2	1.25	.20	.60	1.00	.25	2.75	3.25	.25	.35	.30	.75						
Sterling Silver or Yellow Gold Filled (Engine Turned).....	4	2.00	.40	.60	1.15	.25	3.25	3.75	.25	.35	.30	.75						
Sterling Silver or Yellow Gold Filled (Engine Turned).....	6	3.50	.60	.60	1.50	.25	4.00	4.25	.25	.35	.30	.75						
Green Gold Filled (Engine Turned).....	0	1.00	.10	.50	1.00	.25	2.50	3.00	.25	.40	.25							
Green Gold Filled (Engine Turned).....	2	1.25	.20	.60	1.25	.25	3.00	3.25	.25	.40	.30	.85						
Green Gold Filled (Engine Turned).....	4	2.00	.40	.60	1.35	.25	3.75	4.50	.25	.40	.30	.85						
Sterling Silver (Hand Engraved).....	2	1.25	.20	.60	1.00	.25	4.50	4.50	.25	.35	.30	.75						
Sterling Silver (Hand Engraved).....	4	2.00	.40	.60	1.15	.25	6.50	7.50	.25	.35	.30	.75						
All Tinted (Rose or Green) (Gold on Silver).....	2	1.25	.20	.60	1.00	.25	2.75	3.25	.25	.35	.30	.75						
14K. Yellow Solid Gold.....	2 Ring	1.25	.20	.60	4.00	.25	18.00	22.00	.25	1.25	.30							
14K. Yellow Solid Gold.....	2 Ring	1.25	.20	.60	4.00	.25	23.00	27.00	.25	1.25	.30							
14K. Yellow Solid Gold.....	2 Ring	1.25	.20	.60	4.00	.25	25.00	29.00	.25	1.25	.30							
14K. Yellow Solid Gold.....	2 Ring	1.25	.20	.60	5.00	.25	32.00	35.50	.25	1.25	.30							
18K. Green Solid Gold.....	2 Ring	1.25	.20	.60	5.50	.25	24.00	28.00	.25	1.50	.30							
18K. Green Solid Gold.....	2 Ring	1.25	.20	.60	5.50	.25	26.50	29.50	.25	1.50	.30							
18K. Green Solid Gold.....	2 Ring	1.25	.20	.60	5.50	.25	26.50	29.50	.25	1.50	.30							
18K. Green Solid Gold.....	2 Ring	1.25	.20	.60	6.00	.25	35.00	37.50	.25	1.50	.30							
<b>PYRALIN AND RUBBER</b>																		
Rubber Nos. 52, 62, and 72.....	2	1.25	.20	.60	.75	.25	1.00		.25	.30	.25	.75	.25	1.90	1.25	.75		
Black and Pearl No. 62.....	2	1.25	.20	.60	.75	.25	1.50		.25	.30	.25	.75	.25	2.00	1.25	.75		
Rubber and Pyralin Nos. 64 and 84.....	4	2.00	.40	.60	.75	.25	1.75		.25	.30	.25	.75	.25	3.15	1.75	1.00		
Bronze-Green, Black and Pearl Nos. 64 and 84.....	4	2.00	.40	.60	.75	.25	2.75		.25	.30	.25	.75	.25	3.40	2.00	1.25		
Rubber and Pyralin No. 86.....	6	3.50	.60	.60	.75	.25	2.25		.25	.30	.25	.75	.25	2.90	2.00	1.25		
Bronze-Green, Black and Pearl No. 86.....	6	3.50	.60	.60	.75	.25	3.25		.25	.30	.25	.75	.25	2.50	1.75			
Interchangeable Unit No. 4 Nib.....		2.85																
Interchangeable Unit No. 6 Nib.....		4.35																



# Index

## Introduction

Policy and Guarantee	Pages 2 to 4 inc.
The Merchandise	Pages 5 and 6
Personal-Point Pens, Pencils to match	Pages 7 to 21 inc.
Wahl-Eversharp Pens, Pencils to match	Pages 22 to 30 inc.
Egvi-Poised, Personal-Point Pens, Pencils to match	Pages 31 to 35 inc.
Wahl-Eversharp Knife Set Combination	Page 36
Wahl-Eversharp Fountain Pen Desk Sets	Pages 37 to 62 inc.
Wahl-Eversharp Desk Pencils	Page 65
Wahl-Eversharp Statuettes, Name Plates	Pages 64 to 66 inc.
Wahl-Eversharp Precious Metal Pens and Pencils	Pages 67 to 76 inc.
Wahl-Eversharp Enamel, Bakelite, Rubber and Pyralin Checking Pencils	Pages 77 to 82 inc.
Wahl Well Ink	Page 85
Eversharp Red Top Leads	Pages 84 to 87 inc.
Wahl-Eversharp Gold Pen Points	Page 88
Emblem Caps and Hand Engraving	Page 89
Repair Parts Price List	Pages 90 and 91